

Model/s
EBM529W
EBM529X

Version
V2.0 0323

Everything you need
for your **529L Bottom
Mount Refrigerator**
is in this **User Manual**

esatto

Welcome

Residentia Group

—

Head Office

165 Barkly Avenue
Burnley, Victoria
Australia 3121

—

ACN

600 546 656

—

Online

residentia.group

www.esatto.house

  @esatto.house

—

Postage

PO Box 5177

Burnley, Victoria

Australia 3121

—

Telephone

1300 11 4357

Congratulations on purchasing your new Refrigerator. The Esatto brand is proudly distributed within Australia by Residentia Group Pty Ltd.

Please refer to the warranty card at the rear of this manual for information regarding your product's parts and labour warranty, or visit us online at: www.residentia.group

At Residentia Group, we are customer obsessed and our Support Team are there to ensure you get the most out of your appliance. Should you want to learn more about your new refrigerator, it's features or importantly taking care of the appliance, our Support Team are here to help.

You can use our online Support Centre at anytime by visiting:
<http://support.residentiagroup.com.au>

Or you can contact us via phone by dialing: 1300 11 HELP (4357).

It is important that you read through the following use and care manual thoroughly to familiarise yourself with the installation and operation requirements of your appliance to ensure optimum performance.

Again, thank you for choosing an Esatto appliance and we look forward to being of service to you.

Kind Regards,
The Residentia Team

Contents

Page 02
Welcome

Page 05
Safety Warnings

Page 08
Product Overview

Page 09
Getting Started

Page 09
Installation

Page 13
**Using Your
Refrigerator**

Page 15
Usage Tips

Page 15
Energy Saving Tips

Page 16
**Maintenance
& Cleaning**

Page 18
**FAQs &
Troubleshooting**

Page 20
Specifications

Page 21
Purchase Details

Page 21
Your Receipt

Page 22
Warranty

esatto
everything
you need

Safety Warnings

IMPORTANT SAFETY INSTRUCTIONS READ CAREFULLY AND KEEP FOR FUTURE REFERENCE

Read this manual thoroughly before first use, even if you are familiar with this type of product. The safety precautions enclosed herein reduce the risk of fire, electric shock and injury when correctly adhered to. Make sure you understand all instructions and warnings.

Keep the manual in a safe place for future reference, along with the completed warranty card and purchase receipt. If you sell or transfer ownership of this product, pass on these instructions to the new owner.

Always follow basic safety precautions and accident prevention measures when using an electrical appliance, including the following:

IMPORTANT: Pay particular attention to messages that contain the words **DANGER, WARNING or CAUTION**. These words are used to alert you to a potential hazard that can seriously injure you and others. The instructions will tell you how to reduce the chance of injury and let you know what can happen if the instructions are not followed.



WARNING
RISK OF FIRE / FLAMMABLE MATERIALS

This symbol alerts you to take care as this appliance contains a flammable refrigerant (isobutane) and insulation blowing gas (cyclopentane). Do not expose it to high heat, sparks and open flames.

The refrigerant isobutane (R600a) is contained within the refrigerant circuit of the appliance, a gas with a high level of environmental compatibility, which is nevertheless flammable. During transportation and installation of the appliance, ensure that none of the components of the refrigerant circuit become damaged.

WARNING: Do not damage the refrigerant circuit! Never use an appliance with a damaged refrigerant circuit! If the refrigerant circuit becomes damaged, avoid proximity to open fires and all types of heat and ignition sources. Thoroughly ventilate the room in which the appliance is located.

DANGER: It is hazardous for anyone other than an authorised service person to service this appliance. In Queensland, the authorised service person **MUST** hold a Gas Work Authorisation for hydrocarbon refrigerants to carry out servicing or repairs which involve the removal of covers.

The room for installing the appliance must be at least 1m³ per 8g of refrigerant. The amount and type of refrigerant in the appliance can be found in the Technical Specifications on page 17 and on the rating plate, found on the appliance.

Usage Conditions and Restrictions

- **Domestic use only:** This appliance is intended for indoor household use only. It is not intended for commercial, industrial or outdoor use. It is not intended for use in a recreational vehicle.
- **Purpose:** Do not use this appliance for anything other than its intended purpose. Other uses are not recommended and may cause fire, electric shock or personal injury.
- **Attachments:** The use of attachments is not recommended by the appliance manufacturer and distributor as they may be hazardous.
- **Improper use:** Damage due to improper use, or repairs made by unqualified personnel will void your warranty. We assume no liability for any eventual damages caused by misuse of the product or noncompliance with these instructions.

Safety Warnings (Continued)

General Safety Instructions Cont.

- **WARNING:** Do not use mechanical devices or other means to accelerate the defrosting process, other than those recommended by the manufacturer.
- **Usage restriction:** This appliance is not intended for use by persons (including children) with reduced physical, sensory or mental capabilities, or lack of experience and knowledge, unless they have been given supervision or instructions concerning use of the appliance by a person responsible for their safety.
- **Children:** Supervise young children to ensure they do not play with the appliance. Never allow children to operate, climb, play with or crawl inside the appliance.
- **WARNING:** Do not use electrical appliances inside the appliance, unless they are of the type recommended by the manufacturer.
- **Explosive or flammable substances:** Do not store explosive substances such as aerosol cans with a flammable propellant in or on this appliance. Do not store or use petrol or any other flammable vapours and liquids in the vicinity of this or any other appliance. Do not use such substances for cleaning the appliance. The fumes can create a fire hazard or an explosion.
- **Damage:** Do not use the appliance if the power cord, plug or the appliance itself is damaged. If the cord is damaged, contact the after sales support line and have the cord replaced by qualified personnel in order to avoid a hazard.
- **WARNING:** Do not damage the refrigerant circuit.
- **Do not modify:** Do not attempt to alter or modify this appliance in any way.
- **Repair:** Do not attempt to repair or replace any part of this appliance unless it is specifically recommended in this manual. All other servicing should be referred to a qualified technician. Contact the after sales support line for advice.
- **WARNING:** Do not locate multiple portable socket-outlets or portable power supplies at the rear of the appliance

Electrical Safety

- **Voltage:** Before connecting and turning on the appliance, ensure the electrical voltage and circuit frequency correspond to that indicated on the appliance rating label.
- **Earthing:** This appliance should be properly earthed for your safety. The power cord of this appliance is equipped with a three-prong plug for use in standard wall outlets to minimise the possibility of electrical shock. Do not modify the cord and/or plug provided with the appliance. Improper use of the earthed plug can result in the risk of electric shock.
- **Connection:** This appliance requires a standard 220-240 V AC 50Hz electrical outlet. Do not overload the electrical circuit.
- **Power cord:** Do not kink or damage the power cord; do not leave it exposed or dangling. Secure it at the back of the appliance so no one steps on or places anything on the cord or against it. Keep the cord out of reach of children. When moving the appliance, make sure not to damage the power cord.
- **WARNING:** When positioning the appliance, ensure the supply cord is not trapped or damaged.
- **Auxiliary Items:** Do not use an inverter, adaptor or extension cord with this appliance. If the cord is too short, have a qualified electrician install an outlet near the appliance. Use of an extension cord and an inverter can negatively affect the performance of the unit.
- **Protect from moisture:** To protect against the risk of electric shock, do not immerse the unit, cord or plug in water or spray it with any other liquid. Do not connect or disconnect the electric plug when your hands are wet. Turn the power switch off before removing the plug from the socket.
- **WARNING: Disconnect!** To reduce the risk of fire, electric shock or personal injury, always unplug the appliance from the socket when not in use, when moving and before cleaning or servicing. Never unplug the unit by pulling the power cord. Always grip the plug firmly and pull straight out from the power point.
- **Electrical work:** Any electrical work required for the installation of this appliance should be carried out by a qualified electrician.

Never use this appliance with a damaged refrigerant circuit! If the coolant circuit becomes damaged, avoid proximity to open fires and all types of heat sources. The room in which the appliance is located should be ventilated for a few minutes.

Installation

Heavy: This appliance is heavy, take care when moving it. To avoid back or other injury, consider a two person lift or mechanical aid when installing it. Failure to do so can result in back or other injury.

Damage: When unpacking, check the appliance carefully for damage. If it is damaged, do not install the appliance. Contact our after sales support centre on 1300 43 57 for advice on examination or return of the damaged appliance.

Protect from moisture: Install the appliance in an indoor area protected from wind, rain, water spray or drips.

Protect from heat: Do not install the appliance next to an oven, grill or other source of high heat, or where it will be exposed to direct sunlight for prolonged periods of time.

WARNING: Ventilation: To ensure proper ventilation, keep any ventilation openings, in the appliance enclosure or in the built-in structure, clear of obstructions. Ensure adequate air circulation around the appliance to prevent overheating.

Level: Install the appliance level in order to ensure proper operation.

To Avoid Food Contamination

To avoid contamination of food, please respect the following advice:

- Opening the door for long periods can cause a significant increase of temperature within the refrigerator.
- Clean surfaces regularly that can come in contact with food and accessible drainage systems.
- Clean water tanks if they have not been used for 48 hours; flush the water system connected to a water supply if water has not been drawn for 5 days.*
- Store raw meat and fish in suitable containers in the refrigerator to avoid contact with other foods or avoid dripping on other foods.
- Two-star frozen-food compartments are suitable for storing pre-frozen food, icecream and ice cubes.*
- One, two, and three-star compartments are not suitable for freezing fresh food.*
- If the appliance is left empty for long periods, switch off, defrost, clean, dry and leave the door open to prevent mould developing within the appliance.

* *Please confirm whether it is appliance according to your appliance model and compartment type.*

Cleaning and Maintenance

Disconnect: Unplug the appliance before cleaning or servicing. Failure to do so can result in electric shock, injury or death. Do not connect or disconnect the plug when your hands are wet.

Flames: Do not let open flames or ignition sources enter the appliance.

Flammable/explosive substances: Never clean this appliance with flammable fluids. Do not store or use volatile, flammable or explosive propellants or liquids in or close to this or any other appliance. The fumes can create a fire hazard or explosion.

Solvents: Do not use solvent based cleaning agents or abrasives on the interior as these may damage or discolour the surfaces of the appliances.

WARNING! Do not use mechanical devices or other means to accelerate the defrosting process. Never use a sharp or metal instrument to remove frost or clean the appliance. Use a plastic scraper, if necessary.

Service: Do not attempt to repair, modify or replace any part of the appliance unless specifically recommended in this manual. Refer all other servicing to a qualified technician, or contact the after sales support line for advice on examination or repair of the appliance.

Responsible disposal

Note: At the end of its working life, do not throw this appliance out with your household rubbish. Electrical and electronic products contain substances that can have a detrimental effect on the environment and human health if disposed of inappropriately. Observe any local regulations regarding the disposal of electrical consumer goods and dispose of it appropriately for recycling and recovery of the refrigerant and blowing agent. Contact your municipal authorities for advice on recycling facilities in your area.

WARNING! This refrigeration appliance contains flammable refrigerants and insulation blowing gases, which must be removed before disposal. Contact your municipal authorities for any codes or regulations concerning the disposal of such materials.

Product Overview

Your Refrigerator

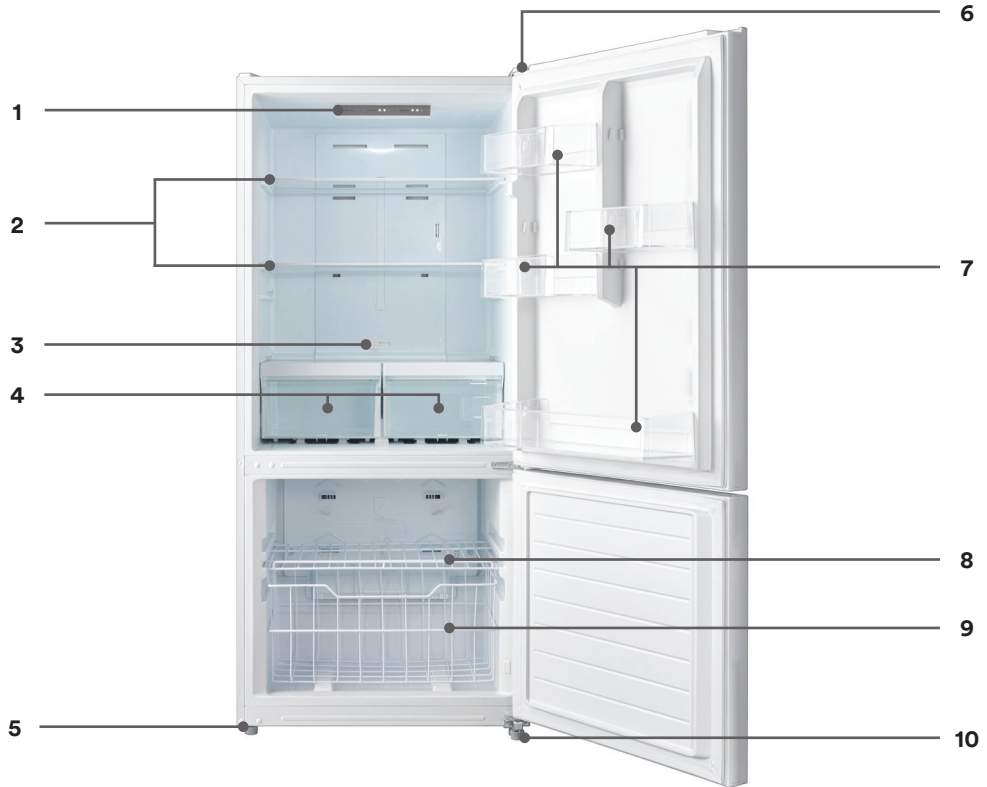

Key:

- | | |
|---|----------------------------------|
| 1. Temperature control panel & LED lighting | 6. Top hinge assembly |
| 2. Glass shelves (x2) | 7. Door trays (various) |
| 3. Humidity control | 8. Steel wire shelf |
| 4. Fruit and vegetable crisper drawers | 9. Steel wire drawer |
| 5. Adjustable foot | 10. Bottom hinge assembly + foot |

The images in this user manual are for demonstration purposes only. Your fridge may appear differently.

Getting Started

Unpacking

- **Packaging materials:** This appliance has been packaged to protect it against transportation damage. Remove all packaging materials from around and inside the appliance and keep the original packaging carton and materials in a safe place. It will help prevent any damage if the product needs to be transported in the future, and you can use it to store the appliance when it is not in use. In the event the carton is to be disposed of, please recycle all packaging materials where possible.
- **Suffocation:** Plastic wrapping can be a suffocation hazard for babies and young children, so ensure all packaging materials are out of their reach and disposed of safely.
- **Power cord:** Unwind the power cord to its full length and inspect it for damage. Do not use the appliance if it or its cord have been damaged or are not working properly. In case of damage, contact our after sales support line for advice on examination, repair or return of the damaged product.
- **Read the manual:** Read this manual to familiarise yourself with the appliance. Pay particular attention to the safety instructions on the previous pages.
- **Clean:** To remove any dust from transit and storage, clean the interior and exterior surfaces of the appliance with lukewarm water and a soft cloth. Dry thoroughly. **Important:** do not use harsh or abrasive detergents or powders as these will damage the finish.

Installation

- **Two person installation:** Use two or more people to move and install the appliance. Failure to do so can result in back or other injury.
- **Freestanding design:** This appliance is designed to be freestanding only, and should not be recessed or built-in.
- **Floor surface:** This appliance must be properly positioned on a dry, sturdy, level surface that is strong enough to support it when it is fully loaded.
- **Ambient temperature:** The ambient temperatures must correspond to the climate class (T) indicated on the rating plate of the appliance: 16°C – 38°C
- **Clearances:** Ensure that air can circulate freely around the back of the cabinet, which is necessary to cool the compressor and condenser. Allow at least 10cm clear space at the back, 10cm at the sides of the unit and 20cm between the top and any surface above (i.e. a bench top). If you are installing your refrigerator next to a fixed wall, leave sufficient space on the hinge side to allow for the door to swing open.

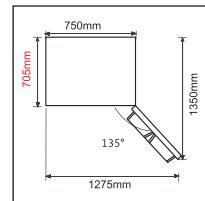

Do NOT install/use the appliance in the following locations/situations:

- In moist areas or areas of high humidity.
- In a recreational vehicle, or for use with an inverter.
- In direct sunlight, near heat sources, next to an open flame, cooking or heating appliance, or near any other source of high heat.
- Direct sunlight may affect the acrylic coating and heat sources may increase the unit's power consumption. For best energy efficiency install the appliance in the coolest area of the room.
- In an area with extreme cold ambient temperatures.
- In an area with excessive moisture and high humidity. Make sure it is protected from elements such as wind, rain, water spray or drips.
- In an area where petrol or other explosive and/or flammable liquids or fumes are used or stored. The fumes can create a fire hazard or explosion.

Installation (Continued)

Installation Cont.

Electrical connection

- **WARNING!** It must be possible to disconnect the appliance from the mains power supply; the plug must therefore be easily accessible after installation.
- Before plugging in your fridge, let it stand upright for at least 2 hours. This will allow the refrigerant gases to settle into the compressor and reduce the possibility of a malfunction in the cooling system.
- The appliance must be earthed. The plug of the power supply cord is equipped with a contact for this purpose. Do not under any circumstances cut or remove the third (earth) prong from the power cord. If the plug does not fit your outlet, consult a licensed electrician for advice to have the outlet changed.
- Plug the unit into a dedicated, properly earthed wall outlet. Ensure that your outlet voltage and circuit frequency correspond to the voltage stated on the rating label.
- Secure the fridge's supply cord behind the unit. Do not leave it exposed or dangling to prevent injury and accidental disconnection from the power supply.
- When first starting up, and after a period out of use, allow the unit to cool down for at least 2–3 hours (4 hours if starting up during warm weather in summer) before placing food in the fridge.

Reversing the door

- Unplug your refrigerator and remove all food from the door shelves. Remove all food from the inner door liner. Fix the door by tape.

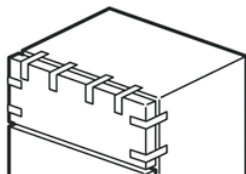

- Remove the top hinge cover. Using a screwdriver, remove the top hinge assembly by unscrewing the hinge screws that secure it. Keep the screws for reuse.

cover plate

top hinge cover

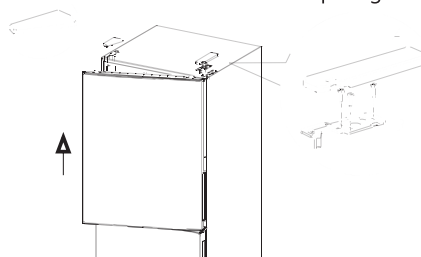

- Lift the door can up and away from your refrigerator. Unscrew the screws of the middle hinge, remove the hinge and then lift the freezer door up and away from your refrigerator. Save the screws for reuse.

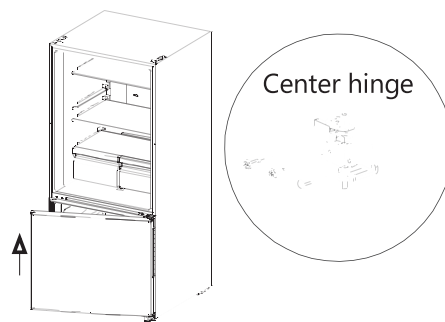

- Using a screwdriver, remove the bottom hinge and hinge shaft from the the bottom of the refrigerator and reinstall them to the opposite side.
- Reinstall the bottom hinge assembly and foot to the opposite sides.
- Dismantle the sleeves from the top of the door, hole cap and assembly and fit them on the opposite side.

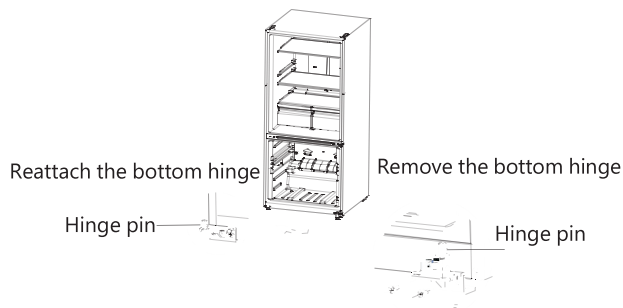

- Remove the refrigerator door stopper and install it on the other side of the door. Remove the freezer door self-locking block and stopper, save them for reuse. Take the self-locking block and stopper from the accessory bag in the refrigerator and install them on the opposite side.

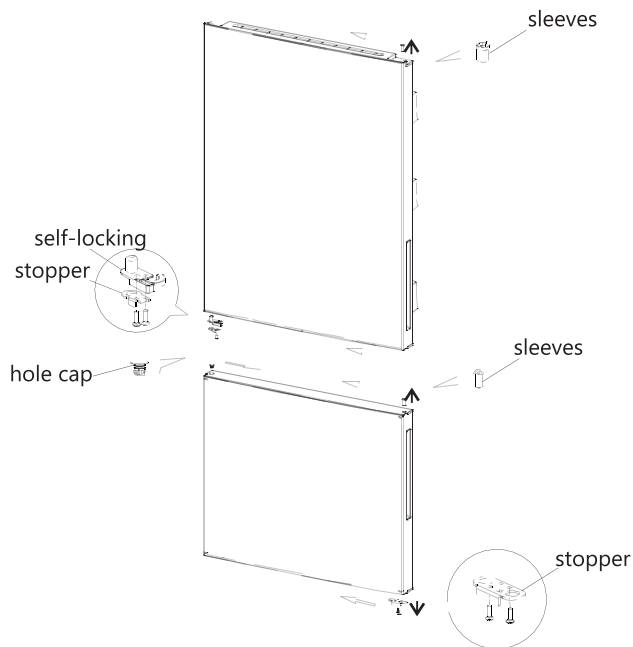

Installation (Continued)

Installation Cont.

- Place down the refrigerator door bottom hinge vertically, take out the middle hinge of the opposite side from the accessory bag and then assemble the middle hinge on.

Attach the center hinge

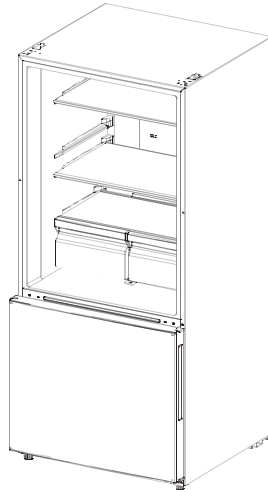
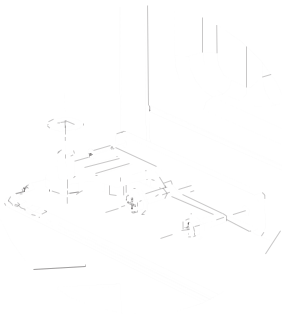

- Place down the freezer door on the middle hinge vertically, take out the top hinge and cover of the opposite side from the accessory bag and then assemble the top hinge, hinge cover and hole cover.

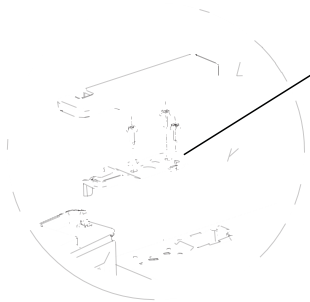

top hinge

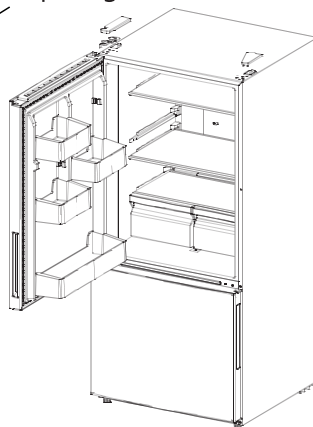

hole cover



The images in this user manual are for demonstration purposes only. Your fridge may appear differently.

Using Your Refrigerator

Fridge Compartment

- The fridge compartment is suitable for storage of a variety of fruits, vegetables, beverages and other foods to be consumed in short term.
- Ensure that hot food has cooled down to room temperature before putting it into the fridge.
- Ensure that your food is sealed up before placing into the fridge.
- The glass shelves can be adjusted up and down for your convenience.

Freezer Compartment

- The freezer compartment may keep food fresh for a long period of time and it is mainly used to store frozen food and making ice.
- The freezer compartment is suitable for the storage of meat, fish, rice and other foods to be consumed in short term.

Note: Storage of too much food during operation after the initial connection to power may adversely affect the freeze effect of the refrigerator. Foods stored should not block the air outlet; otherwise the freezing effect will also be adversely affected.

Temperature Control Panel

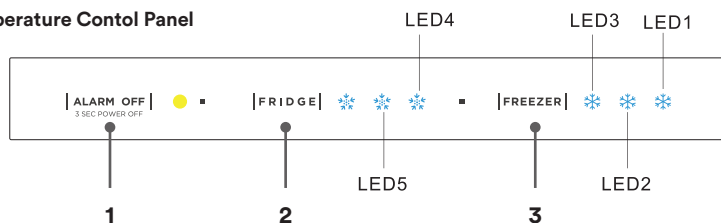

1. Alarm / Power off/ Power on button
2. Refrigerator thermostat button
3. Freezer thermostat button

Display

- When power is initially connected, the display will light for 3 seconds. After the alert sounds, the display will resume normal operation.
- The LED lights will display the set refrigeration setting. In the event of a failure, a loop display or fault code will display.

The images in this user manual are for demonstration purposes only. Your fridge may appear differently.

Using Your Refrigerator (Continued)

Installation Cont.

Refrigerator settings

- Press the refrigeration key to adjust the setting. Press the key once to change to the next settings as follows:



Freezer settings

- Press the freezer key to adjust the setting. Press the key once to change to the next settings as follows:

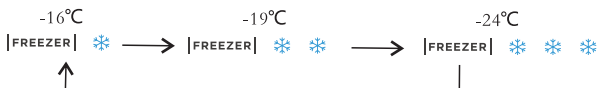

Alarm off

- When a fault alarm occurs, press the alarm off key to cancel the alarm sound.

Mute reminder alert

- When the fridge or freezer door is opened for 120 seconds without closing, a reminder alert will sound until the door is closed. Press the alarm off button to cancel the alert sound.

Ice maker

- After 40 seconds of normal operation of the refrigerator, the ice maker will open.

Standby mode

- Press the alarm key and hold for 3 seconds to enter standby mode. All lights and display will be turned off. Long press the alarm off button 3 seconds to return to normal operation.

Humidity Control

- When the Humidity Control is adjusted to the far right, fruits and vegetables can be stored in the crisper drawers. Quick-freezing mode is closed.
- When the Humidity Control is adjusted to the far left, quick-freezing mode is open. Fruits and vegetables cannot be stored in the crisper drawers.

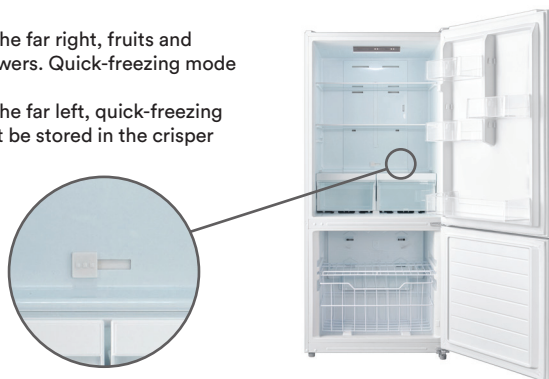

The images in this user manual are for demonstration purposes only. Your fridge may appear differently.

Usage Tips

- Do not store food uncovered in the fridge. Always use good quality, fridge-proof packaging to maintain food quality. Remove air from packages of solid food and seal bags tightly before freezing.
- Keep portions small to ensure they are frozen (and subsequently defrosted) rapidly.
- Make sure that fresh, unfrozen food packages do not touch food that is already frozen, thus avoiding a temperature rise in the frozen food.
- When freezing food, do not push food together too much, leave some space for air to circulate around each item. Do not place packages directly against the back wall.
- When buying frozen food, only buy quantities that you can store straight away; use an insulated container for your shopping and when you get home, place the food in the freezer compartment immediately.
- When storing pre-packed, commercially frozen food, follow the food manufacturer's instructions for storing the food in a home fridge or freezer. Do not exceed any storage times listed on the packaging.
- Once you have opened a packet of frozen food, re-wrap it airtight to prevent surface evaporation which causes drying or freezer burn.
- Do not place carbonated liquids such as bottles of fizzy drink in the freezer compartment as the container could explode under pressure and damage the chiller.
- Do not refreeze food once it has been defrosted.
- Frozen food which has thawed accidentally should either be used immediately or thrown away. Alternatively, if the food is uncooked and has not been completely defrosted, it may be cooked and then refrozen.
- **CAUTION!** Do not remove items from the freezer compartment if your hands are damp or wet as this could cause skin abrasions.

Energy Saving Tips

- The appliance should be placed in the coolest area of the room, away from heat producing appliances or heating ducts. Please avoid placement in direct sunlight.
- Let hot foods cool to room temperature before placing them in the appliance.
- Do not overload the appliance with unfrozen food as this may cause it to freeze slowly and risk food spoilage.
- Be sure to wrap foods properly and wipe containers dry before placing them in the appliance. This cuts down on frost building up inside in the unit.
- Please do not wrap items in aluminium foil, wax paper or paper towel. This materials interfere with cold air circulation, making the appliance less efficient.
- Organise and label food to reduce door openings and extended searches. Remove as many items as needed at one time, ensuring the unit is opened as few times as possible.

Maintenance & Cleaning

Cleaning

WARNING

Before cleaning the appliance, make sure it is switched off and disconnected from the power supply.

Failure to do so can result in electric shock or injury.

- Dust behind the refrigerator and on the ground shall be timely cleaned to improve the cooling effect and energy saving.
- Check the door gasket regularly to make sure there are no debris. Clean the door gasket with a soft cloth dampened with soapy water or diluted detergent.
- The interior of the refrigerator should be cleaned regularly to avoid odor.
- Please turn off the power before cleaning interior, remove all foods, drinks ,shelves, drawers, etc.
- Use a soft cloth or sponge to clean the inside of the refrigerator, with two tablespoons of baking soda and a quart of warm water. Then rinse with water and wipe clean. After cleaning, open the door and let it dry naturally before turning on the power.
- For areas that are difficult to clean in the refrigerator (such as narrow sandwiches, gaps or corners), it is recommended to wipe them regularly with a soft rag, soft brush, etc. and when necessary, combined with some auxiliary tools (such as thin sticks) to ensure no contaminants or bacterial accumulation in these areas.
- Do not use soap, detergent, scrub powder, spray cleaner, etc., as these may cause odors in the interior of the refrigerator or contaminated food.
- Clean the bottle frame, shelves and drawers with a soft cloth dampened with soapy water or diluted detergent. Dry with a soft cloth or dry naturally.
- Wipe the outer surface of the refrigerator with a soft cloth dampened with soapy water, detergent, etc , and then wipe dry.
- Do not use hard brushes, clean steel balls, wire brushes, abrasives (such as toothpastes), organic solvents (such as alcohol, acetone, banana oil, etc.), boiling water, acid or alkaline items, which may damage the fridge surface and interior. Boiling water and organic solvents such as benzene may deform or damage plastic parts.
- Do not rinse directly with water or other liquids during cleaning to avoid short circuits or affect electrical insulation after immersion.

- **Never use boiling water to accelerate defrosting as it may damage the plastic components.**

- After everything is dry, place appliance back into operation.
- Allow approximately 1–2 hours for the cabinet to cool down again (depending on the length of time the appliance was disconnected from the power).

WARNING

Never clean the unit with an abrasive, acid, oil or solvent based cleaning agent. Never use flammable fluids or sprays for cleaning as the fumes from these substances can create a fire hazard or Explosion.

Defrosting

The refrigerator is made based on the air-cooling principle and thus has automatic defrosting function. Frost formed due to change of season or temperature may also be manually removed by disconnection of the appliance from power supply or by wiping with a dry towel.

Cleaning the door trays

- According to the direction arrow in the figure below, use both hands to squeeze the tray, and push it upward, then you can take it out.
- After washing the tray having been taken out, you can adjust its installing height in accordance with your requirement.

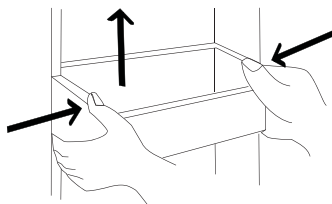

Maintenance and Cleaning Cont.

Cleaning the glass shelves

Since the shelf and box gill have the innermost stop, first lift the shelf up, and then pull outwards to remove, adjust height or clean.

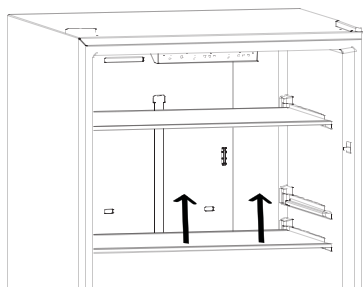

Cleaning the gill bottom roller groove

- First pull out the fruit and vegetable box, because the fruit and vegetable box has a stop, it needs to lift be lifted upward before the fruit and vegetable box can be removed.

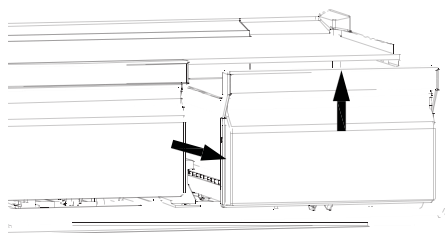

- The roller seat is stuck in the box tank groove, press the arrow in the direction of the image, remove the roller seat, clean the box tank groove as needed.

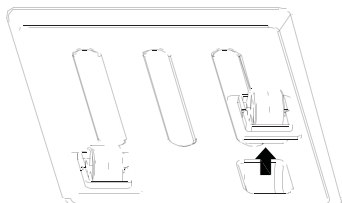

Out of operation

- Power failure: Most power failures are corrected within a few hours and should not affect the temperature of your appliance if you minimise the number of times the door is opened. If the power is going to be off for a longer period of time, take proper steps to protect the contents.
- Long-term storage: The appliance must be unplugged and cleaned; the doors must be left open to prevent odour.
- Moving: Before the refrigerator is moved, take all objects inside out, fix the glass partitions, crisper drawers, freezer drawers and etc. with tape, and tighten the levelling feet; close the doors and seal them with tape. During moving, the appliance shall not be laid upside down or horizontally, or be vibrated; the inclination during movement shall be no more than 45°.

Service, repair and spare parts

Do not attempt to alter or modify this appliance in any way, or to repair or replace any part unless it is specifically recommended in this manual. All other servicing should be referred to a qualified technician. Contact our after sales support on 1300 11 43 57 for advice.

Our after sales support centre stocks a selection of spare parts for the Esatto 529L Bottom Mount Refrigerator. To enquire about purchasing a part, call us on 1300 11 43 57 or email support@residentiagroup.com.au

FAQs & Troubleshooting

| Problem | Possible Cause | Possible Solution |
|---|--|--|
| The appliance does not operate. | <ul style="list-style-type: none"> • The appliance is not plugged in. • The appliance is turned off. • The circuit breaker tripped or a blown fuse. | <ul style="list-style-type: none"> • Plug in the appliance. • Turn on power point. • Reset circuit breaker/replace fuse. |
| The appliance has an odd odour. | <ul style="list-style-type: none"> • Food may not be wrapped properly. • Food may be rotten. • The interior may not be clean. | <ul style="list-style-type: none"> • Check that the food is wrapped tightly. • Check for rotten food and remove. • Clean the interior of the appliance. |
| The compressor is operating for a long time | <ul style="list-style-type: none"> • Ambient temperature may be high. • Too much food may be stored in the appliance. • Hot food is stored in the appliance. • The doors are opened too frequently. | <ul style="list-style-type: none"> • This is normal, especially in summer. • Reduce the amount of food stored in the appliance. • Ensure the food has cooled before placing in the refrigerator. • Limit the frequency of door openings. |
| The internal light does not illuminate. | <ul style="list-style-type: none"> • The appliance is not plugged in. • The appliance is turned off. • The circuit breaker tripped or a blown fuse. • The light is damaged. | <ul style="list-style-type: none"> • Plug in the appliance. • Turn on power point. • Reset circuit breaker/replace fuse. • Please contact after sales support. |
| The door will not close. | <ul style="list-style-type: none"> • The appliance is not level. • Food is preventing door closure. | <ul style="list-style-type: none"> • Level the appliance. • Re-position food so it does not obstruct. |
| The door seal is loose | <ul style="list-style-type: none"> • Foreign matter may be on the seal • Seal may need restoration | <ul style="list-style-type: none"> • Clean the door seal • Please contact after sales support. |
| Water pan overflows | <ul style="list-style-type: none"> • Too much food may be stored in the appliance or food may have a large water contents resulting in heavy defrosting. • Door may not be closed properly. | <ul style="list-style-type: none"> • Reduce the amount of food stored in the appliance. • Close the door. |
| Warm or hot housing | <ul style="list-style-type: none"> • Heat dissipation of the built-in condenser via the housing may become hot due to high ambient temperature, storage of too much food or not enough ventilation to help facilitate heat dissipation. | <ul style="list-style-type: none"> • This is normal, especially in summer. • Reduce the amount of food stored in the appliance. • Ensure the stored food allows for effective circulation within the refrigeration |

| | | |
|----------------------|---|--|
| Surface condensation | <ul style="list-style-type: none"> Condensation may appear on the exterior surface or door seals due to high ambient temperatures. | <ul style="list-style-type: none"> Wipe away the condensation with a clean towel. |
| Abnormal sounds. | <ul style="list-style-type: none"> The compressor may buzz during operation. Particular during start or stop of operation. Refrigerant flowing inside of the appliance may produce a creak noise. The appliance is touching the wall causing vibrations. | <ul style="list-style-type: none"> This is normal. This is normal. Move the appliance away from the wall and check it is level. |

Fault Indication

The following warnings appearing on the display indicate corresponding faults of the appliance. Although the appliance may appear to be operating normally, we recommend contacting after sales support to ensure normal use and longevity.

| Fault code | Fault indication | Fault description |
|------------|--------------------|---------------------------------------|
| E1 | LED 1 & 2 flashing | Refrigerator temperature sensor fault |
| E2 | LED 1 & 5 flashing | Freezer temperature sensor fault |
| E5 | LED 1 & 3 flashing | Freezing frost sensor fault |
| E6 | LED 2 & 4 flashing | Communication failure |
| E7 | LED 1 & 4 flashing | Ring temperature fault |

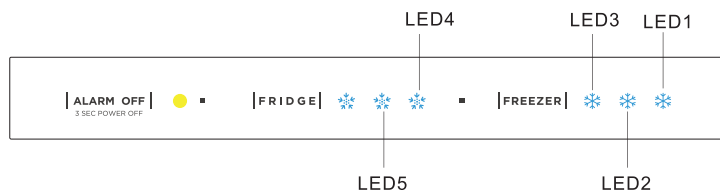

Specifications

| | |
|----------------------------|--|
| Model: | EBM529W, EBM529X |
| Product Dimensions: | W: 750mm, D: 785mm, H: 1692mm |
| Weight: | 76kg |
| Gross Capacity: | 529L |
| Other Features: | 370 litre refrigerator capacity, 159 litre freezer capacity, Reversible door, Glass shelves, Electronic temperature controls, Automatic defrost system, Interior LED lighting, Adjustable Feet |
| Energy Rating: | 3.5 Stars MEPS |

Purchase Details

For your records, please record details of your purchase below and staple your receipt on the opposite page.

The serial number can be found at the rear of your appliance.

STORE DETAILS

STORE NAME |

ADDRESS |

TELEPHONE |

PURCHASE DATE |

PRODUCT DETAILS

MODEL NO. |

SERIAL NO.* |

Attach your receipt to this page



Warranty

WARRANTY TERMS AND CONDITIONS REFRIGERATION APPLIANCES

This document sets out the terms and conditions of the product warranties for Residentia Group Appliances. It is an important document. Please keep it with your proof of purchase documents in a safe place for future reference should you require service for your Appliance.

1. **IN THIS WARRANTY**
 - (a) 'acceptable quality' as referred to in clause 10 of this warranty has the same meaning referred to in the ACL;
 - (b) 'ACL' means Trade Practices Amendment (Australian Consumer Law) Act (No.2) 2010;
 - (c) 'Appliance' means any Residentia Group product purchased by you accompanied by this document;
 - (d) 'ASR' means Residentia Group authorised service representative;
 - (e) 'Residentia Group' means Residentia Group Pty Ltd of 165 Barkly Ave, Burnley VIC 3121, ACN 600 546 656 in respect of Appliances purchased in Australia;
 - (f) 'major failure' as referred to in clause 10 of this warranty has the same meaning referred to in the ACL and includes a situation when an Appliance cannot be repaired or it is uneconomic for Residentia Group, at its discretion, to repair an Appliance during the Warranty Period;
 - (g) 'Warranty Period' means:
 - (i) where the Appliance is used for personal, domestic or household use (i.e. normal single family use) as set out in the instruction manual, the Appliance is warranted against manufacturing defects for 24 months, following the date of original purchase of the Appliance;
 - (h) 'you' means the purchaser of the Appliance not having purchased the Appliance for re-sale, and 'your' has a corresponding meaning.
2. This warranty only applies to Appliances purchased and used in Australia and is in addition to (and does not exclude, restrict, or modify in any way) any non-excludable statutory warranties in Australia.
3. During the Warranty Period Residentia Group or its ASR will, at no extra charge if your Appliance is readily accessible for service, without special equipment and subject to these terms and conditions, repair or replace any parts which it considers to be defective. Residentia Group or its ASR may use remanufactured parts to repair your Appliance. You agree that any replaced Appliances or parts become the property of Residentia Group. This warranty does not apply to light globes, batteries, seals, filters or similar perishable parts.
4. Parts and Appliances not supplied by Residentia Group are not covered by this warranty.

5. You will bear the cost of transportation, travel and delivery of the Appliance to and from Residentia Group or its ASR. If you reside outside of the service area, you will bear the cost of:
 - (a) travel of an authorised representative;
 - (b) transportation and delivery of the Appliance to and from Residentia Group or its ASR, in all instances, unless the Appliance is transported by Residentia Group or its ASR, the Appliance is transported at the owner's cost and risk while in transit to and from Residentia Group or its ASR.
6. Proof of purchase is required before you can make a claim under this warranty.
7. You may not make a claim under this warranty unless the defect claimed is due to faulty or defective parts or workmanship. Residentia Group is not liable in the following situations (which are not exhaustive):
 - (a) the Appliance is damaged by:
 - (i) accident
 - (ii) misuse or abuse, including failure to properly maintain or service
 - (iii) normal wear and tear
 - (iv) power surges, electrical storm damage or incorrect power supply
 - (v) incomplete or improper installation
 - (vi) incorrect, improper or inappropriate operation
 - (vii) insect or vermin infestation
 - (viii) failure to comply with any additional instructions supplied with the Appliance;
 - (b) the Appliance is modified without authority from Residentia Group in writing;
 - (c) the Appliance's serial number or warranty seal has been removed or defaced;
 - (d) the Appliance was serviced or repaired by anyone other than Residentia Group, an authorised repairer or ASR.
8. This warranty, the contract to which it relates and the relationship between you and Residentia Group are governed by the law applicable where the Appliance was purchased.
9. To the extent permitted by law, Residentia Group excludes all warranties and liabilities (other than as contained in this document) including liability for any loss or damage whether direct or indirect arising from your purchase, use or non use of the Appliance.
10. For Appliances and services provided by Residentia Group in Australia, the Appliances come with a guarantee by Residentia Group that cannot be excluded under the Australian Consumer Law. You are entitled to a replacement or refund for a major failure and for compensation for any other reasonably foreseeable loss or damage. You are also entitled to have the Appliance repaired or replaced if the Appliance fails to be of acceptable quality and the failure does not amount to a major failure. The benefits to you given by this warranty are in addition to your other rights and remedies under a law in relation to the Appliances or services to which the warranty relates.
11. At all times during the Warranty Period, Residentia Group shall, at its discretion, determine whether repair, replacement or refund will apply if an Appliance has a valid warranty claim applicable to it.
12. Missing parts are not covered by warranty. Residentia Group reserves the right to assess each request for missing parts in a case by case basis. Any parts that are not reported missing in the first week after purchase will not provide free of charge.
13. To enquire about claiming under this warranty, please follow these steps:
 - (a) carefully check the operating instructions, user manual and the terms of this warranty;
 - (b) have the model and serial number of the Appliance available;
 - (c) have the proof of purchase (e.g. an invoice) available;
 - (d) telephone the numbers shown below.
14. You accept that if you make a warranty claim, Residentia Group and its ASR may exchange information in relation to you to enable Residentia Group to meet its obligations under this warranty.

IMPORTANT

Before calling for service, please ensure that the steps in point 13 have been followed.

CONTACT SERVICE

→ Please call 1300 11 HELP (4357)



E2447

esatto
everything
you need



A RESIDENTIA
GROUP INITIATIVE