

Model/s
ECI604T

Version
V1.1 0123

Everything you need
for your 60cm Induction
Cooktop is in this
User Manual

esatto

Welcome

Residentia Group

—

Head Office

165 Barkly Avenue
Burnley, Victoria
Australia 3121



—

ACN

600 546 656

—

Online

residentia.group
www.esatto.house
  @esatto.house

—

Postage

PO Box 5177

Burnley, Victoria
Australia 3121

—

Telephone

1300 11 4357

Congratulations on purchasing your new Induction Cooktop. The Esatto brand is proudly distributed within Australia by Residentia Group Pty Ltd.

Please refer to the warranty card at the rear of this manual for information regarding your product's parts and labour warranty, or visit us online at: www.residentia.group

At Residentia Group, we are customer obsessed and our Support Team are there to ensure you get the most out of your appliance. Should you want to learn more about your new cooktop, it's features or importantly taking care of the appliance, our Support Team are here to help.

You can use our online Support Centre at anytime by visiting: <http://support.residentiagroup.com.au>

Or you can contact us via phone by dialing: 1300 11 HELP (4357).

It is important that you read through the following use and care manual thoroughly to familiarise yourself with the installation and operation requirements of your appliance to ensure optimum performance.

Again, thank you for choosing an Esatto appliance and we look forward to being of service to you.

Kind Regards,
The Residentia Team

Contents

Page 2
Welcome

Page 4
Safety Instructions

Page 8
Installation
Instructions

Page 12
Product Overview

Page 13
Operating
Instructions

Page 20
Cooking Advice

Page 21
Maintenance
& Cleaning

Page 22
Troubleshooting

Page 25
Technical Data

Page 26
Your Receipt

Page 27
Purchase Details

Page 28
Warranty

Safety Instructions

IMPORTANT SAFETY INSTRUCTIONS READ CAREFULLY AND KEEP FOR FUTURE REFERENCE

Read this manual thoroughly before first use, even if you are familiar with this type of product. The safety precautions enclosed in here reduce the risk of electric shock and injury when correctly adhered to. Make sure you understand all instructions and warnings.

Keep the user manual in a safe place for future reference, along with the completed warranty information and purchase receipt. If you sell or transfer ownership of this product, pass on these instructions to the new owner.

Always follow basic safety precautions and accident prevention measures when using an electrical appliance. The following statements you will see in this booklet have these meanings:

WARNING: Indicating information concerning your personal safety.

CAUTION: Indicating information on how to avoid damaging the appliance, benchtop or cabinetry.

IMPORTANT: Indicating tips and information about use of the appliance.

USAGE CONDITIONS AND RESTRICTIONS

- **Domestic use only:** This appliance is intended for indoor household use only. It is not intended for commercial, industrial or outdoor use. It is not intended for use in a recreational vehicle.
- **Purpose:** Do not use this appliance for anything other than its intended purpose. Other uses are not recommended and may cause fire, electric shock or personal injury.
- **Attachments:** The use of attachments is not recommended by the appliance manufacturer and distributor as they may be hazardous.
- **Improper use:** Damage due to improper use, or repairs made by unqualified personnel will void your warranty. We assume no liability for any eventual damages caused by misuse of the product or noncompliance with these instructions.

IMPORTANT: The appliance must be installed using the instructions in this user manual. The manufacturer is not responsible for any damage that might be caused by defective placement, and incorrect installation.

This appliance is not intended for use by persons (including children) with reduced physical, sensory or mental capabilities or lack of experience and knowledge unless they have been given supervision or instruction concerning use of the appliance by a person responsible for their safety.

- Children should be supervised to ensure that they do not play with the appliance.
- If the supply cord is damaged, it must be replaced by the manufacturer, its service agent or similarly qualified persons in order to avoid a hazard.
- This appliance is intended for indoor domestic (or household) use only, and is not intended for commercial, trade or industrial use.
- Do not repair or replace any part of the appliance unless specifically recommended in the manual. All other servicing should be done by a qualified technician.

BEFORE USING YOUR APPLIANCE

Prior to using your Induction Cooktop, please read all safety and operating instructions thoroughly. Please ensure you follow the steps below before using this product:

- This cooktop must only be installed in accordance with the instructions provided. Incorrect installation may cause harm to persons, damage property and void the product's warranty.
- Unpack the appliance but keep all packaging materials until you have made sure the new Induction Cooktop is undamaged and in good working order. We recommend you keep the original packaging for storing your Induction Cooktop when not in use or transporting.
WARNING: Plastic wrapping can be a suffocation hazard for babies and children, so ensure all packaging materials are out of their reach.

IMPORTANT: Inspect the appliance for any damage heck for any damage or defects. In the case of damage, do not use this product and contact the Residentia Group support team on 1300 11 HELP (4357) for further advice should you wish to claim for damage/marks under the manufacturer's warranty. This does not affect your statutory rights.

WARNING: ELECTRICAL HAZARDS

It is important to use your cooktop safely. Follow these instructions carefully to avoid potential electric shock, fire or death.

- In certain circumstances electrical appliances may be a safety hazard. Check the conformity of voltage and power settings, which are specified on the information plate attached to the appliance and/or packaging, with the usage conditions available.
- Disconnect the appliance from the mains electricity supply before carrying out any work or maintenance on it.
- Alterations to the domestic wiring system must only be made by a qualified electrician.
- A means for disconnection must be incorporated in the fixed wiring in accordance with the wiring rules.
- If the appliance is being hardwired, it must be installed by an authorised technician.
- If the supply cord or plug is damaged, it must be replaced by the manufacturer, its service agent or similarly qualified persons in order to avoid a hazard.
- Do not cook on a broken or cracked cooktop. If the cooktop surface should break or crack, switch the appliance off immediately at the mains power supply (wall switch) and contact a qualified technician.
- The electrical connection must be accessible after installation.

WARNING: HEALTH HAZARD

Follow these instructions carefully to avoid potential injury or death.

- This appliance complies with electromagnetic safety standards.
- However, persons with cardiac pacemakers or other electrical implants (such as insulin pumps) must consult with their doctor or implant manufacturer before using this appliance to make sure that their implants will not be affected by the electromagnetic field.
- Failure to follow this advice may result in death.

WARNING: RISK TO CHILDREN

- The appliance can be used by children aged from 8 years and above and persons with reduced physical, sensory or mental capabilities or lack of experience and knowledge if they have been given supervision or instruction concerning use of the appliance in a safe way and understand the hazards involved. Children shall not play with the appliance.
- Children should be supervised to ensure that they do not play with, sit, stand, or climb on the appliance.
- Do not store items of interest to children in cabinets above the appliance. Children climbing on the cooktop could be seriously injured.
- Cleaning and user maintenance shall not be made by children without supervision.
- This appliance is not intended for use by persons (including children) with reduced physical, sensory or mental capabilities, or lack of experience and knowledge, unless they have been given supervision or instruction concerning use of the appliance by a person responsible for their safety.
- Remove all packaging before using the appliance. Otherwise, serious damage or injury may result.

Safety Instructions (Continued)

CAUTION: CUT HAZARD

Follow these instructions carefully to avoid a potential injury.

- Take care - panel edges are sharp.
- The razor-sharp blade of a cooktop scraper is exposed when the safety cover is retracted. Use with extreme care and always store safely and out of reach of children.
- Failure to use caution could result in injury or cuts.

WARNING: CRACKED SURFACE

If the surface is cracked, switch off the appliance to avoid the possibility of electric shock, for cooktop surfaces of glass-ceramic or similar material which protect live parts.

CAUTION: INSTALLING THE APPLIANCE

- To avoid a hazard, this appliance must be installed according to the instructions in this user manual for installation. Failure to install the appliance correctly could invalidate any warranty or liability claims.
- This appliance should be connected to a circuit which incorporates an isolating switch providing full disconnection from the power supply.
- All cabinetry and materials used in the installation must be able to withstand a minimum temperature of 50°C above the ambient temperature of the room it is located in, whilst in use.
- Certain types of vinyl or laminate kitchen furniture are particularly prone to heat damage or discolouration at temperatures below the guidelines given above.
- Any damage caused by the appliance being installed without adhering to the temperature limits set out above will be the liability of the owner. To avoid any hazards, limit access to the under-bench section of the cooktop.
- Damage can occur to bench tops if pots and pans are allowed to overlap the bench top. This can result in heat being transferred to the bench top.
- Ensure that correct sized pots & pans are used. Pans should be lifted on and off the cooktop surface and not dragged. Cooking zones should not be switched on without cookware placed on it. Do not place empty cookware onto the cooking zones when in use.

WARNING: OPERATING THE APPLIANCE

- The appliance and its accessible parts become hot during use.
- Care should be taken to avoid touching heating elements.
- Unattended cooking on a cooktop with fat or oil can be dangerous and may result in a fire. NEVER try to extinguish a fire with water, but switch off the appliance and then cover flame e.g. with a lid or a fire blanket.
- The cooking process has to be supervised. A short term cooking process must always be supervised at all times. Boilover causes smoking and greasy spillovers that may ignite.
- The appliance and its accessible parts become hot during use. Care should be taken to avoid touching heating elements
- Do not store items on the cooking surfaces.
- Never leave any objects or utensils on the appliance. Metallic objects such as knives, forks, spoons and lids should not be placed on the cooktop surface since they can get hot
- The appliance is not intended to be operated by means of an external timer or separate remote-control system.
- Do not place heavy objects on the appliance, use for storage or as a cutting surface as sharp edges can damage the surface.
- This appliance is designed for cooking food only.
- Use flat based, stable, inductive cooking rated cookware only.
- Only use cooktop guards designed by the manufacturer of the cooking appliance or indicated by the manufacturer of the appliance in the instructions for use as suitable or cooktop guards incorporated in the appliance. The use of inappropriate guards can cause accidents.
- No combustible material or products should be placed on this appliance at any time.
- During use, accessible parts of this appliance will become hot enough to cause burns.
- Do not let your body, clothing or any item other than suitable cookware contact the Induction glass until the surface is cool.
- Handles of saucepans may be hot to touch. Check saucepan handles do not overhang other cooking zones that are on. Keep handles out of reach of children. Failure to follow this advice could result in burns and scalds.
- Never use your appliance as a work or storage surface.
- Do not place or leave any magnetic objects

(e.g. credit cards, memory cards) or electronic devices (e.g. computers, mobile phones) near the appliance, as they may be affected by its electromagnetic field.

- Never use your appliance for warming or heating the room.
- After use, always turn off the cooking zones and the cooktop as described in this manual (i.e. by using the touch controls). Do not rely on the pan detection feature to turn off the cooking zones when you remove the pans.
- Do not place or drop heavy objects or stand on your cooktop.
- Do not use pans with jagged edges or drag pans across the Induction glass surface as this can scratch the glass.
- Ensure that the kitchen is well ventilated or mechanical ventilation is in use while cooking on this appliance.
- Do not store or use flammable materials or aerosols near the cooktop. Items made from aluminium, plastic, plastic film & sugar-based foods should also be kept away from the appliance, as they may fuse to the surface.
- **WARNING** The surface temperature of this appliance exceeds 95°C. To avoid a hazard, under bench access must be restricted. A board must be installed underneath the cooktop. Heat from the underside of the unit will be expelled by inbuilt fans – do not block.
- **WARNING** The cooktop will become hot during and directly after use. Do not touch the surface during this time, as it may be hot and can cause burns. To avoid burns and injury, children should be kept away.
- Do not modify this appliance

CAUTION: CLEANING & MAINTENANCE

- Cleaning may only be commenced on the appliance once it has cooled down and is turned off. Failure to clean properly can damage the cooktop.
- Do not use a steam clean, steam jet or any other high-pressure cleaning equipment to clean the appliance.
- Do not use scourers or any other harsh abrasive cleaning agents to clean your cooktop, as these can scratch the Induction glass.

UNPACKING

During transportation, protective packaging was used to protect the appliance against any damage. After unpacking, please dispose of all elements of packaging in a way that will not cause damage to the environment.

All materials used for packaging the appliance are environmentally friendly; they are 100% recyclable and are marked with the appropriate symbol.

CAUTION: During unpacking, the packaging materials (polythene bags, polystyrene pieces, etc.) should be kept out of reach of children.

RESPONSIBLE DISPOSAL

The symbol on the product, or in its packaging, indicates that this product may not be treated as household waste. Instead, it should be taken to the appropriate waste collection point for the recycling of electrical and electronic equipment.

By ensuring this product is disposed of correctly, you will help prevent potential negative consequences for the environment and human health, which could otherwise be caused by the inappropriate waste handling of this product.

For more detailed information about the recycling of this product, please contact your local council, your household waste disposal service, or the shop where you purchased the product.



Installation Instructions

BEFORE INSTALLING THE COOKTOP

IMPORTANT: The appliance must be installed using the instructions in this user manual. The manufacturer is not responsible for any damage that might be caused by defective placement, and incorrect installation.

- The work surface is square and level, and no structural members interfere with space requirements.
- The work surface is made of a heat-resistant and insulated material.
- If the cooktop is installed above an oven, the oven has a built-in cooling fan.
- The installation will comply with all clearance requirements and applicable standards and regulations.
- A suitable isolating switch providing full disconnection from the mains power supply is incorporated in the permanent wiring, mounted and positioned to comply with the local wiring rules and regulations.
- You consult local building authorities and by-laws if in doubt regarding installation.
- You use heat-resistant and easy-to-clean finishes (such as ceramic tiles) for the wall surfaces surrounding the cooktop.
- Cut out the work surface according to the sizes shown in the drawing. For the purpose of installation and use, leave a minimum of 50mm space around the cut out.

Be sure the thickness of the work surface is at least 30mm. Please select heat-resistant and insulated work surface material (Wood and similar fibrous or hygroscopic material shall not be used as work surface material unless impregnated) to avoid the electrical shock and larger deformation caused by the heat radiation from the hotplate.

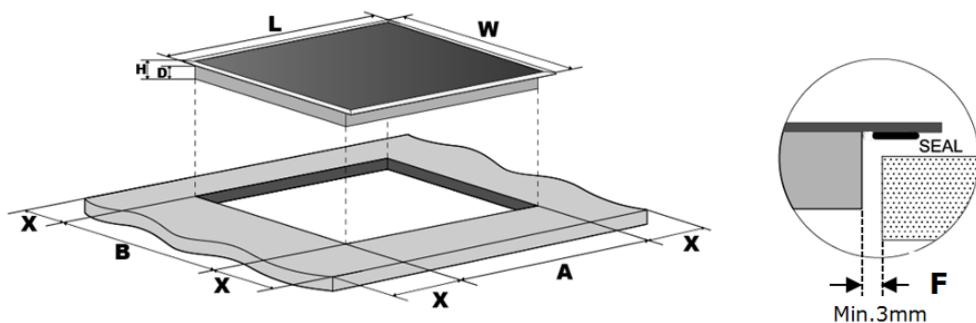

As shown below:

L (mm)	W (mm)	H (mm)	D (mm)	A (mm)	B (mm)	X (mm)	F (mm)
590	520	60	56	560 +4 +1	490 +4 +1	50 minimum	3 minimum

NOTE:

- The safety distance between the sides of the cooktop and the inner surfaces of the worktop should be at least 3mm.
- Under any circumstances, make sure the Induction cooker hob is well ventilated and the air inlet and outlet are not blocked. Ensure the induction cooker hob is in good work state. As shown below:
- **WARNING** The safety distance between the hotplate and the cupboard above the hotplate should be at least 650 mm.

Under all circumstances, make sure the induction cooktop is well ventilated and the air inlet and outlet are not blocked. Ensure the induction cooktop is in good working state (as shown below).

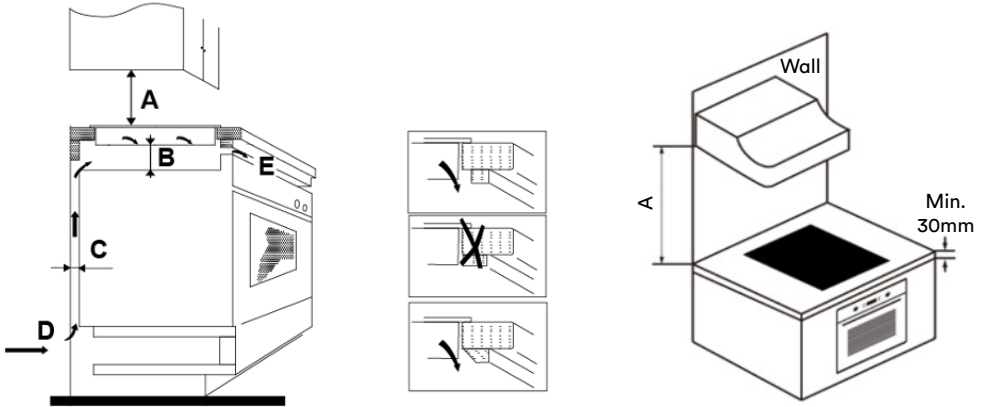

A	B (mm)	C (mm)	D (mm)	E (mm)
Please refer to your rangehood's user manual for minimum clearances from the top of the cooktop surface to your rangehood	50 minimum	50 minimum	Air intake	Air ventilation: 5mm

WARNING: ENSURING ADEQUATE VENTILATION

Make sure the induction cooktop is well ventilated and that air inlet and outlet is not blocked. In order to avoid accidental touch with the overheating bottom of the cooktop, or getting unexpected electric shock during working, it is necessary to put a wooden insert, fixed by screws, at a minimum distance of 50mm from the bottom of the cooktop. Follow the requirements below.

IMPORTANT

- There are ventilation holes around outside of the cooktop. You must ensure these holes are not blocked by the worktop when you put the cooktop into position.
- Be aware that the glue that join the plastic or wooden material to the furniture, has to resist to temperature not below 150 °C, to avoid the unstuck of the paneling.
- The rear wall, adjacent and surrounding surfaces must therefore be able to withstand an temperature of 90 °C.

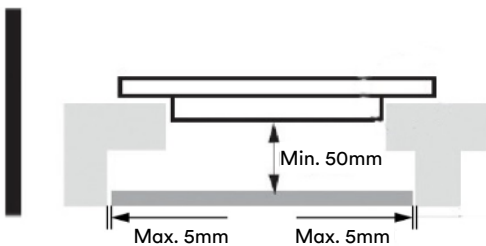

Installation Instructions (Continued)

AFTER INSTALLING THE COOKTOP

- The power supply cable is not accessible through cupboard doors or drawers.
- There is adequate flow of fresh air from outside the cabinetry to the base of the cooktop.
- If the cooktop is installed above a drawer or cupboard space, a thermal protection barrier is installed below the base of the cooktop.
- The isolating switch is easily accessible by the user.

APPLYING THE FIXING BRACKETS

- The unit should be placed on a stable, smooth surface (such as the packaging). Do not apply force onto the controls protruding from the cooktop.
- Fix the cooktop on the work surface by screwing the two brackets on the bottom of the cooktop after installation (see diagram below).
- Adjust the bracket position to suit for different table top thickness.

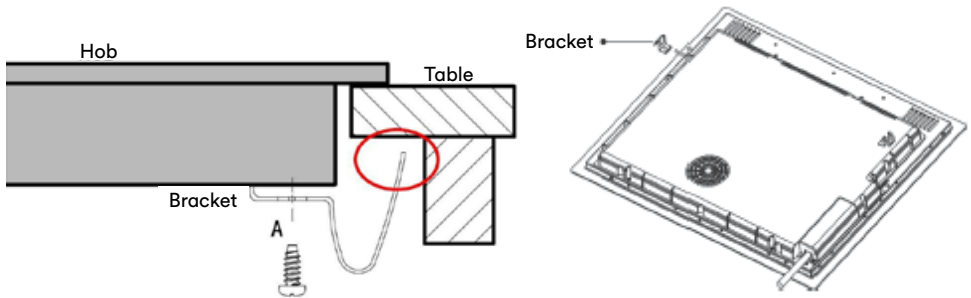

IMPORTANT: Under no circumstances are the brackets to touch with the inner surfaces of the worktop after installation (see diagram above).

CAUTIONS:

- The appliance must be installed using the instructions in this user manual. The manufacturer is not responsible for any damage that might be caused by defective placement, and incorrect installation.
- If you are not confident to conduct the installation by yourself, please contact our Service team on 1300 11 HELP (4357) to allocate you a qualified technician.
- Do not install the cooktop directly above a dishwasher, fridge, freezer, washing machine or clothes dryer, as the humidity may damage the cooktop electronics
- The induction hotplate shall be installed such that better heat radiation can be ensured to enhance its reliability.
- The wall and induced heating zone above the table surface shall withstand heat.
- To avoid any damage, the sandwich layer and adhesive must be resistant to heat.
- Do not use a steam cleaner.

CONNECTING THE HOB TO THE MAINS POWER SUPPLY

This appliance is provided with a 10A power plug.

Before connecting the hob to the mains power supply, check that:

- The domestic wiring system is suitable for the power drawn by the hob.
- The voltage corresponds to the value given in the rating plate
- The power supply cable sections can withstand the load specified on the rating plate.

To connect the hob to the mains power supply, do not use adapters, reducers, or branching devices, as they can cause overheating and fire.

The power supply cable must not touch any hot parts and must be positioned so that its temperature will not exceed 75°C at any point.

- If the cable is damaged or to be replaced, the operation must be carried out by the after-sale agent with dedicated tools to avoid any accidents.
- If the appliance is being connected directly to the mains an omnipolar circuit-breaker must be installed with a minimum opening of 3mm between contacts.
- The installer must ensure that the correct electrical connection has been made and that it is compliant with safety regulations.
- The cable must not be bent or compressed.
- The cable must be checked regularly and replaced by authorised technicians only.

WARNING:

- Allow disconnection of the appliance after installation.
- If the appliance is being hardwired, a means for disconnection must be incorporated in the fixed wiring in accordance with the wiring rules.

SERVICING

- Servicing **MUST** only be carried out by authorised personnel.
- To maintain safe operation, it is recommended that the product be inspected every five years by an authorised service person.
- If the supply cord is damaged, it must be replaced by the manufacturer, its service agent or similarly qualified persons in order to avoid a hazard.

WARNING: Never install a cooktop that has been damaged. Please contact our Service Team for assistance.

Product Overview

YOUR INDUCTION COOKTOP

This cooktop has been designed with a power limiter to ensure the cooktop does not exceed 2200W, allowing it to be plugged in to a standard 10amp power socket.

Note: If hardwiring, the power limitations will remain.

TOP VIEW

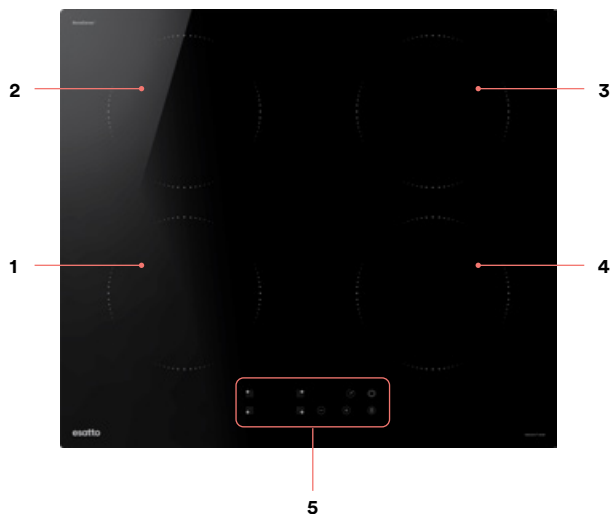

KEY

1. 1500W Zone
2. 2000W Zone
3. 1500W Zone
4. 2000W Zone
5. Touch control panel

CONTROL PANEL

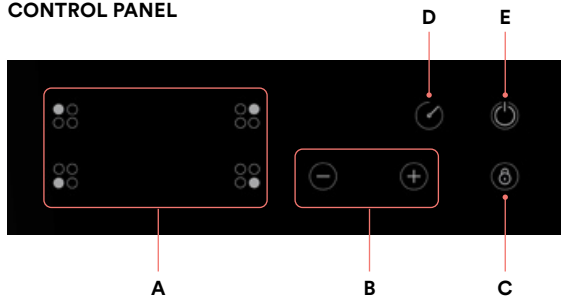

KEY

- A. Zone selection controls
- B. Power & Timer regulating controls
- C. Child lock button
- D. Timer button
- E. Power button

Note:

The images in this user manual are for reference only. Your appliance may appear differently.

Operating Instructions

INDUCTION COOKING INFORMATION

Induction cooking is a safe, advanced, efficient, and economical cooking technology. It works by electromagnetic vibrations generating heat directly in the pan, rather than indirectly through heating the glass surface. The glass becomes hot only because the pan eventually warms it up.

Before using your new Induction cooktop:

- Read this guide, taking special note of the 'Safety Instructions' section.
- Remove any protective film or stickers that may still be on your induction cooktop.

USING THE COOKTOP

Operating the cooktop using only one or two zones will provide optimal results.

As the cooktop is equipped with a power limiter, when more zones are turned on the power level will change for each zone.

You can use any one zone at power level 9 (full power).

When using any two zones together, the max power levels will be:

- Zone 1: Power level 7
- Zone 2: Power level 6
- Zone 3: Power level 7
- Zone 4: Power level 7

When using any three zones together, the max power levels will be at power level 6.

When using all four zones together, the max power levels will be:

- Zone 1: Power level 5
- Zone 2: Power level 5
- Zone 3: Power level 5
- Zone 4: Power level 6

BOILING WATER GUIDE

The table below shows the approximate times to boil 1 litre of tap water:

POWER LEVEL	1500W Zone	2000W Zone
9	Under 5 minutes Test results: 4:43	Under 3 minutes Test results: 2:54
7	Under 7 minutes Test results: 6:15	Under 6 minutes Test results: 5:40

Note: The above results are indicative only.

Your results may vary depending on cookware and water temperature.

Operating Instructions (Continued)

OPERATION OF YOUR INDUCTION COOKTOP

TOUCH CONTROLS

- The controls respond to touch, so you don't need to apply any pressure.
- Use the ball of your finger, not just the tip.
- You will hear a beep each time a touch is registered.
- Make sure the controls are always clean, dry, and that there is no object (e.g. a utensil or a cloth) covering them. Even a thin film of water may make the controls difficult to operate.

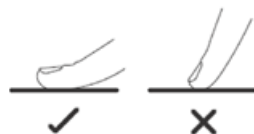

CHOOSING THE RIGHT COOKWARE

- Only use cookware with a base suitable for induction cooking.
- Look for the induction mark on the packaging or on the bottom of the pan.
- You can check whether your cookware is suitable by checking if the base of the pan is magnetised. If it is, the pan is suitable for induction cooking.
- You can also test by placing some water in a pan, if  displays and the water is not heating, the pan is not suitable.
- Cookware made from pure stainless steel, aluminium or copper without a magnetic base, glass, wood, porcelain, ceramic, and earthenware are not suitable for induction cooking.

Do not use cookware with jagged edges or a curved base.



Make sure that the base of your pan is smooth, sits flat against the glass, and is the same size as the cooking zone. Use pans whose diameter is as large as the graphic of the zone selected. Using a large pot a slightly wider energy will be used at its maximum efficiency. If you use smaller pot, efficiency could be less than expected. Pot less than 140mm could be undetected by the cooktop. Always centre your pan on the cooking zone.

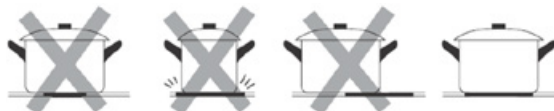

Always lift pans off the induction cooktop – do not slide, or they may scratch the glass.

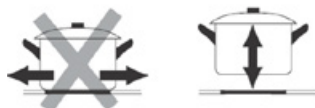

USING YOUR INDUCTION COOKTOP

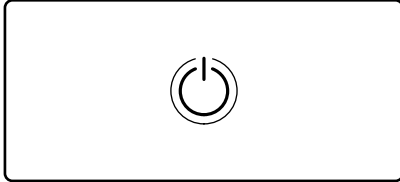

1. Touch the power button for three seconds. After the power is on, the buzzer will beep once and all the displays show either “-” or “--” indicating the cooktop has entered standby mode.

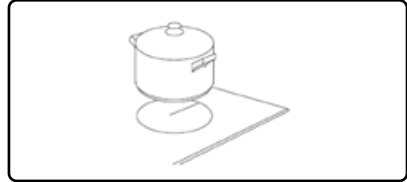

2. Place a suitable pan on the cooking zone that you wish to use. Make sure the bottom of the pan and the surface of the cooking zone are clean and dry.

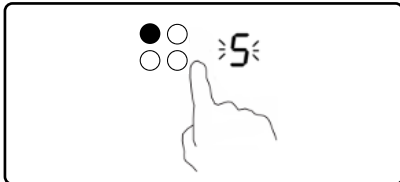

3. When selecting the heating zone of your choice, the indicated next to the button will flash. (See table on page 19 for recommended heat settings)

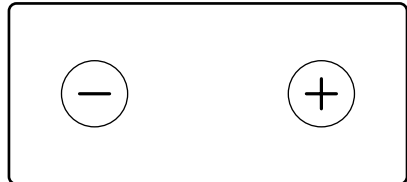

4. Select a heat setting by touching the ‘-’ or ‘+’ buttons.

If you don't choose a heat setting within 1 minute, the induction cooktop will automatically switch off. You will need to start again at step 1. You can modify the heat setting at any time during cooking.

IF THE DISPLAY FLASHES $\geq \leq$ ALTERNATELY WITH THE HEAT SETTING

This means that:

- You have not placed a pan on the correct cooking zone or;
- The pan you're using is not suitable for induction cooking or;
- The pan is too small or not properly centered on the cooking zone.

No heating takes place unless there is a suitable pan on the cooking zone.

The display ‘ $\geq \leq$ ’ will automatically turn off after 1 minute if no suitable pan is placed on it.

Operating Instructions (Continued)

WHEN YOU FINISH COOKING

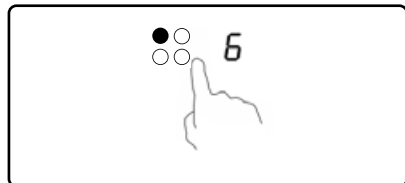

1. Select the cooking zone that you wish to switch off

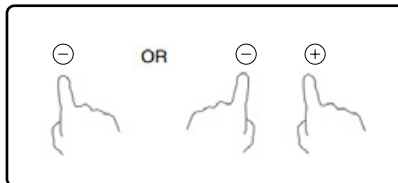

2. Turn the cooking zone off by scrolling down to "0" or simultaneously touching '-' and '+' buttons together

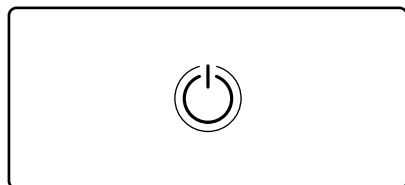

3. Turn the whole cooktop off by touching the ON/OFF power control.

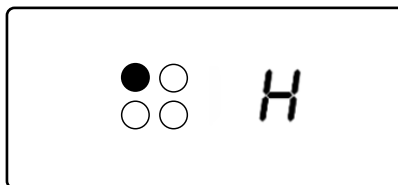

4. Beware of hot surfaces

When there is residual heat, 'H' will show which cooking zone when it is hot to touch. It will disappear when the surface has cooled down to a safe temperature. It can also be used as an energy saving function if you want to heat further pans, use the hotplate that is still hot.

CHILD LOCK CONTROL



You can lock the controls to prevent unintended use (e.g. children accidentally turning the cooking zones on) by pressing the child lock button. The timer indicator will display "Lo" when child lock is enabled. To unlock, touch and hold the child lock button for a few seconds.

When the controls are locked, all the controls except the ON/OFF control are disabled.

TIMER CONTROL

You can use the timer in two different ways:

- **Cooking zone auto-off**

You can use the timer to turn one or more cooking zones off after the set time is up.

The timer of maximum is 99 minutes.

- **Minute minder**

You can use it as a minute minder. In this case, the timer will not turn any cooking zone off when the set time is up, it will instead make a buzzing sound to alert you that the time is up.

USING THE TIMER AS A MINUTE MINDER

Make sure the cooktop is turned on.

Note: You must use at least one active zone to be able to use the minute minder function.



1. Touch the controls of the timer. The minder indicator will start flashing, and “10” will show in the timer display.

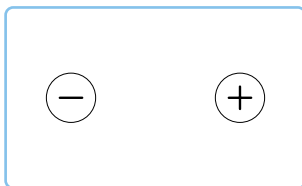

2. Set the time by touching the ‘-’ or ‘+’ timer buttons.

Each touch will decrease or increase by 1 minute increments.

Touch and hold the ‘-’ or ‘+’ buttons to decrease or increase by 10 minute increments.

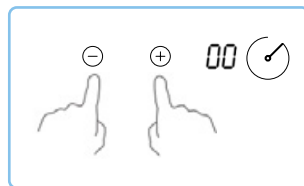

3. To cancel the timer, touch the ‘-’ or ‘+’ buttons together and the “00” will show in the minute display.



4. When the time is set, it will begin to count down immediately. The display will show the remaining time and the timer indicator will flash for 5 seconds.

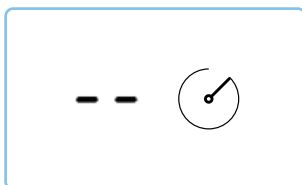

5. The alert will sound for 30 seconds and the timer indicator will display “--” when the setting time finishes. Note: This will not automatically turn off the active cooking zone.

Operating Instructions (Continued)

SETTING THE TIMER TO TURN ONE OR MORE COOKING ZONES OFF

Setting one cooking zone:

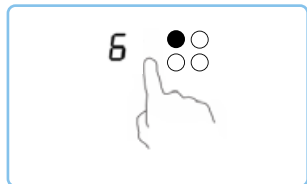

1. Touching the heating zone selection control that you want to set the timer for. (e.g. zone #3)



2. Quickly touch the timer button and the minder indicator will start flashing, and "10" will show in the timer display.

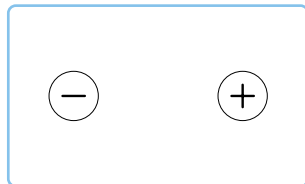

3. Set the time by touching the '-' or '+' timer buttons.

Each touch will decrease or increase by 1 minute increments.

Touch and hold the '-' or '+' buttons to decrease or increase by 10 minute increments.

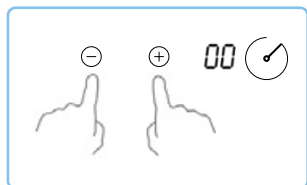

4. To cancel the timer, touch the '-' or '+' buttons together and the "00" will show in the minute display.



5. When the time is set, it will begin to count down immediately. The display will show the remaining time and the timer indicator will flash for 5 seconds.

NOTE: The red dot next to power level indicator will illuminate indicating that zone is selected.

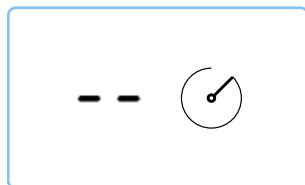

6. When cooking timer expires, the corresponding cooking zone will be switched off automatically.

NOTE:

Other cooking zone will keep operating if they are turned on previously.

The diagrams shown in this user manual are for reference only, your product may appear differently.

DEFAULT WORKING TIMES

Auto shut down is a safety protection function for your induction cooktop. It shuts down automatically if ever you forget to turn off your cooking. The default working times for various power levels are shown in the below table:

Power level	1	2	3	4	5	6	7	8	9
Default working timer (hour)	8	8	8	4	4	4	2	2	2

When the pot is removed, the induction cooktop will stop heating immediately and the cooktop automatically switches off after 2 minutes.

WARNING:

People with a heart pace maker should consult with their doctor before using this cooktop.

HEAT SETTINGS

The settings below are guidelines only. The exact setting will depend on several factors, including your cookware and the amount you are cooking. Experiment with the induction cooktop to find the settings that best suit you.

Power level	Recommended Use
1 - 2	Delicate warming for small amounts of food Melting chocolate, butter, and foods that burn quickly Gentle simmering Slow warming
3 - 4	Reheating Rapid simmering Cooking rice
5 - 6	Pancakes
7 - 8	Sautéing Cooking pasta
9	Stir-frying Searing Bringing soup to the boil Boiling water

Cooking Advice

IMPORTANT:

Take care when frying as oil and fat heat up very quickly. At extremely high temperatures, oils and fat will ignite spontaneously and this presents a serious risk of fire.

COOKING TIPS

- When food comes to the boil, reduce the temperature setting.
- Using a lid will reduce cooking times and save energy by retaining the heat.
- Minimize the amount of liquid or fat to reduce cooking times.
- Start cooking on a high setting and reduce the setting when the food has heated through.

DETECTION OF SMALL ARTICLES

When an unsuitable size or non-magnetic pan (e.g. aluminium), or some other small item (e.g. knife, fork, key) has been left on the cooktop, the cooktop automatically goes on to standby in 1 minute. The fan will keep cooking down the induction cooktop for a further 1 minute.

SIMMERING / COOKING RICE

- Simmering occurs below boiling point, at around 85 °C, when bubbles are just rising occasionally to the surface of the cooking liquid. It is the key to delicious soups and tender stews because the flavours develop without overcooking the food. You should also cook egg-based and flour thickened sauces below boiling point.
- Some tasks, including cooking rice by the absorption method, may require a setting higher than the lowest setting to ensure the food is cooked properly in the time recommended.

SEARING STEAK

To cook juicy flavourful steaks:

1. Stand the meat at room temperature for about 20 minutes before cooking.
2. Heat up a heavy-based frying pan.
3. Brush both sides of the steak with oil. Drizzle a small amount of oil into the hot pan and then lower the meat onto the hot pan.
4. Turn the steak only once during cooking. The exact cooking time will depend on the thickness of the steak and how cooked you want it. Times may vary from about 2 – 8 minutes per side. Press the steak to gauge how cooked it is – the firmer it feels the more 'well done' it will be.
5. Leave the steak to rest on a warm plate for a few minutes to allow it to relax and become tender before serving.

FOR STIR-FRYING

1. Choose an induction compatible flat-based wok or a large frying pan.
2. Have all the ingredients and equipment ready. Stir-frying should be quick. If cooking large quantities, cook the food in several smaller batches.
3. Preheat the pan briefly and add two tablespoons of oil.
4. Cook any meat first, put it aside and keep warm.
5. Stir-fry the vegetables. When they are hot but still crisp, turn the cooking zone to a lower setting, return the meat to the pan and add your sauce.
6. Stir the ingredients gently to make sure they are heated through.
7. Serve immediately.

Maintenance & Cleaning

EVERYDAY MARKS AND SPILLS

To remove everyday marks, fingerprints, food stains and non-sugary spillovers on the glass:

1. Switch the power to the cooktop off.
2. Apply a cooktop cleaner while the glass is still warm (but not hot!)
3. Rinse and wipe dry with a clean cloth or paper towel.
4. Switch the cooktop power back on.

IMPORTANT:

- When the power to the cooktop is switched off, there will be no 'hot surface' indication but the cooking zone may still be hot! Take extreme care.
- Heavy-duty scourers, some nylon scourers and harsh/abrasive cleaning agents may scratch the glass. Always read the label to check if your cleaner or scourer is suitable.
- Never leave cleaning residue on the cooktop as this may stain the glass.

BOIL-OVERS, MELTS AND HOT SUGARY SPILLS ON THE GLASS

Whilst taking caution with hot cooking zone surfaces, remove these immediately with ceramic glass suitable fish slice, palette knife or razor blade scraper.

- Switch the power to the cooktop off at the wall.
- Hold the ceramic glass suitable blade or utensil at a 30° angle and scrape the mess or spill to the cool area of the cooktop.
- Clean the mess or spill up with a dish cloth or paper towel.
- Follow steps 2–4 for "Everyday marks and spills" above.

IMPORTANT:

- Remove stains left by melts and sugary food or spillovers as soon as possible. If left to cool on the glass, they may be difficult to remove or even permanently damage the glass surface.
- Cut hazard: when the safety cover is retracted, the blade in a scraper is razor-sharp. Use with extreme care and always store safely and out of reach of children.

Troubleshooting

OPERATION IN CASE OF EMERGENCY

In the event of an emergency you should:

- Turn the cooktop off by pressing the “On/Off” button.
- Switch off the appliance at the power outlet and remove the plug.
- Call the Residentia Group support team on 1300 11 HELP (4357).

Some minor faults can be fixed by referring to the instructions given in the Troubleshooting section below. There is also a self-help section online at <https://support.residentia.com.au/>

Issue	Possible Cause	Resolution
The cooktop cannot be turned on.	No power.	<ul style="list-style-type: none"> • Make sure the induction cooktop is connected to the power supply and that it is switched on. • Check whether there is a power outage in your home or area. If you've checked everything and the problem persists, call our Service team on 1300 11 HELP (4357)
The touch controls are unresponsive.	The controls are locked.	Unlock the controls using the lock button. See section 'Product Overview' for instructions.
The touch controls are difficult to operate.	There may be a slight film of water over the controls or you may be using the tip of your finger when touching the controls.	Make sure the touch control area is dry and use the ball of your finger when touching the controls.
The glass is being scratched.	Rough-edged cookware. Unsuitable, abrasive scourer or cleaning products being used.	<ul style="list-style-type: none"> • Use cookware with flat and smooth bases. See 'Choosing the right cookware' in the Operation Instructions section. • See 'Maintenance & Cleaning'.
Some pans make crackling or clicking noises.	This may be caused by the construction of your cookware (layers of different metals vibrating differently).	This is normal for cookware and does not always indicate a fault.
The induction cooktop makes a low humming noise when used on a high heat setting.	This is caused by the technology of induction cooking.	This is normal, but the noise should quieten down or disappear completely when you decrease the heat setting.
Fan noise coming from the induction cooktop.	A cooling fan built into your induction cooktop has come on to prevent the electronics from overheating. It may continue to run even after you've turned the induction cooktop off.	This is normal and needs no action. Do not switch the power to the induction cooktop off at the wall while the fan is running.

Issue	Possible Cause	Resolution
Pans do not become hot and no light appears in the display.	<ul style="list-style-type: none"> The induction cooktop cannot detect the pan because it is not suitable for induction cooking. The induction cooktop cannot detect the pan because it is too small for the cooking zone or not properly centered on it. 	<ul style="list-style-type: none"> Use cookware suitable for induction cooking. See section 'Choosing the right cookware'. Centre the pan and make sure that its base matches the size of the cooking zone.
<ul style="list-style-type: none"> The LED does not light up when unit is plugged in. Some buttons are not responding, or the LED display is not normal. 	<ul style="list-style-type: none"> No power supplied. The accessorial power board and the display board connected failure. The accessorial power board is damaged. The display board is damaged. 	<ul style="list-style-type: none"> Check to see if plug is secured tightly in outlet and that outlet is working. Check the connection. Accessorial power board may need replacing. The display board may need replacing.
The Cooking Mode Indicator is lit, but the cooktop is not heating.	<ul style="list-style-type: none"> High temperature of the cooktop. There is something wrong with the fan. The power board is damaged. 	<ul style="list-style-type: none"> Ambient temperature may be too high. Air Intake or Air Vent may be blocked. Fan may need replacing. Power board may need replacing.
Heating stops suddenly during operation and the display flashes "u".	<ul style="list-style-type: none"> Unsuitable cookware. Pot diameter is too small. Cooker has overheated; Cooktop is overheated. 	<ul style="list-style-type: none"> Use suitable cookware. See section 'Choosing the right cookware'. Pan detection circuit may be damaged. Power board may need replacing. Unit is overheated. Wait for temperature to return to normal. Push "ON/OFF" button to restart unit.
Heating zones of the same side (such as zone 1 & 2) display "u".	<ul style="list-style-type: none"> The power board or it's connection may be damaged. The main board is damaged. 	<ul style="list-style-type: none"> Check the connection or replace the display board. Power board may need replacing.
Fan motor sounds abnormal.	The fan motor is damaged.	The fan needs replacing.

NOTE:

If checking any of the the above causes are not easily resolved or you cannot resolve the fault by yourself:

- Turn the cooktop off by pressing the "On/Off" button.
- Switch off the appliance at the power outlet and remove the plug.
- Call the Residentia Group support team on 1300 11 HELP (4357).

Troubleshooting (Continued)

FAULT CODES AND POSSIBLE SOLUTIONS

The induction cooktop is equipped with a self diagnostic function. With this test the technician is able to check the function of several components without disassembling or dismantling the cooktop from the working surface.

WARNING: Never dismantle the cooktop yourself.

FAILURE CODES DURING COOKTOP USE (AUTO-RECOVERY)

FAULT CODE	POSSIBLE CAUSE	RESOLUTION
E1	Supply voltage is above the rated voltage.	Please inspect whether power supply is normal and power on after the power supply is corrected.
E2	Supply voltage is below the rated voltage.	
E3	High temperature of ceramic plate sensor (#1).	Wait for the temperature of the ceramic plate to return to normal. Touch the power button to restart the unit.
E4	High temperature of ceramic plate sensor (#2).	
E5	High temperature of IGBT (#1).	Wait for the temperature of the IGBT to return to normal. Touch the power button to restart the unit. Check whether the fan runs smoothly; if not the fan will require replacing.
E6	High temperature of IGBT (#2).	
F3/F6	Ceramic plate temperature sensor failure –short circuit. (F3 for #1, F6 for #2).	Check the connection or replace the ceramic plate temperature sensor.
F4/F7	Ceramic plate temperature sensor failure –open circuit. (F4 for #1, F7 for #2).	
F5/F8	Ceramic plate temperature sensor failure –invalid. (F5 for #1, F8 for #2).	
F9/FA	Temperature sensor of the IGBT failure. (Short circuit/open circuit for #1).	Replace the power board.
FC/FD	Temperature sensor of the IGBT failure. (Short circuit/open circuit for #2).	

Technical Data

Model:	ECI604T
Cooking Zones:	4 Zones
Total Power:	2200W
Rated Voltage:	220-240V~
Rated Frequency:	50Hz or 60Hz
Product Dimensions (W × D × H):	590mm × 520mm × 60mm
Built-in Dimensions (A × B):	560mm × 490mm
Other Features:	9-Stage Power Settings
	Pan Sensor
	Automatic Safety Switch Off
	Residual Heat Indicators
	99 Minute Timer
	Child Lock

NOTE:

This product is subject to continuous improvement, specification are subject to change without prior notice.

**Attach your receipt
to this page**



Purchase Details

For your records, please record details of your purchase below and staple your receipt on the opposite page. Your serial number can be found on the rating plate of your Cooktop.

STORE DETAILS

STORE NAME |

ADDRESS |

TELEPHONE |

PURCHASE DATE |

PRODUCT DETAILS

MODEL NO. |

SERIAL NO.* |

Warranty

WARRANTY TERMS AND CONDITIONS COOKTOPS

This document sets out the terms and conditions of the product warranties for Residentia Group Appliances. It is an important document. Please keep it with your proof of purchase documents in a safe place for future reference should you require service for your Appliance.

1. **IN THIS WARRANTY**
 - (a) 'acceptable quality' as referred to in clause 10 of this warranty has the same meaning referred to in the ACL;
 - (b) 'ACL' means Trade Practices Amendment (Australian Consumer Law) Act (No.2) 2010;
 - (c) 'Appliance' means any Residentia Group product purchased by you accompanied by this document;
 - (d) 'ASR' means Residentia Group authorised service representative;
 - (e) 'Residentia Group' means Residentia Group Pty Ltd of 165 Barkly Ave, Burnley VIC 3121, ACN 600 546 656 in respect of Appliances purchased in Australia;
 - (f) 'major failure' as referred to in clause 10 of this warranty has the same meaning referred to in the ACL and includes a situation when an Appliance cannot be repaired or it is uneconomic for Residentia Group, at its discretion, to repair an Appliance during the Warranty Period;
 - (g) 'Warranty Period' means:
 - (i) where the Appliance is used for personal, domestic or household use (i.e. normal single family use) as set out in the instruction manual, the Appliance is warranted against manufacturing defects for 24 months, following the date of original purchase of the Appliance;
 - (h) 'you' means the purchaser of the Appliance not having purchased the Appliance for re-sale, and 'your' has a corresponding meaning.
2. This warranty only applies to Appliances purchased and used in Australia and is in addition to (and does not exclude, restrict, or modify in any way) any non-excludable statutory warranties in Australia.
3. During the Warranty Period Residentia Group or its ASR will, at no extra charge if your Appliance is readily accessible for service, without special equipment and subject to these terms and conditions, repair or replace any parts which it considers to be defective. Residentia Group or its ASR may use remanufactured parts to repair your Appliance. You agree that any replaced Appliances or parts become the property of Residentia Group. This warranty does not apply to light globes, batteries, filters, seals or similar perishable parts.
4. Parts and Appliances not supplied by Residentia Group are not covered by this warranty.

5. You will bear the cost of transportation, travel and delivery of the Appliance to and from Residentia Group or its ASR. If you reside outside of the service area, you will bear the cost of:
- travel of an authorised representative;
 - transportation and delivery of the Appliance to and from Residentia Group or its ASR, in all instances, unless the Appliance is transported by Residentia Group or its ASR, the Appliance is transported at the owner's cost and risk while in transit to and from Residentia Group or its ASR.
6. Proof of purchase is required before you can make a claim under this warranty.
7. You may not make a claim under this warranty unless the defect claimed is due to faulty or defective parts or workmanship. Residentia Group is not liable in the following situations (which are not exhaustive):
- the Appliance is damaged by:
 - accident
 - misuse or abuse, including failure to properly maintain or service
 - normal wear and tear
 - power surges, electrical storm damage or incorrect power supply
 - incomplete or improper installation
 - incorrect, improper or inappropriate operation
 - insect or vermin infestation
 - failure to comply with any additional instructions supplied with the Appliance;
 - the Appliance is modified without authority from Residentia Group in writing;
 - the Appliance's serial number or warranty seal has been removed or defaced;
 - the Appliance was serviced or repaired by anyone other than Residentia Group, an authorised repairer or ASR.
8. This warranty, the contract to which it relates and the relationship between you and Residentia Group are governed by the law applicable where the Appliance was purchased.
9. To the extent permitted by law, Residentia Group excludes all warranties and liabilities (other than as contained in this document) including liability for any loss or damage whether direct or indirect arising from your purchase, use or non use of the Appliance.
10. For Appliances and services provided by Residentia Group in Australia, the Appliances come with a guarantee by Residentia Group that cannot be excluded under the Australian Consumer Law. You are entitled to a replacement or refund for a major failure and for compensation for any other reasonably foreseeable loss or damage. You are also entitled to have the Appliance repaired or replaced if the Appliance fails to be of acceptable quality and the failure does not amount to a major failure. The benefits to you given by this warranty are in addition to your other rights and remedies under a law in relation to the Appliances or services to which the warranty relates.
11. At all times during the Warranty Period, Residentia Group shall, at its discretion, determine whether repair, replacement or refund will apply if an Appliance has a valid warranty claim applicable to it.
12. Missing parts are not covered by warranty. Residentia Group reserves the right to assess each request for missing parts in a case by case basis. Any parts that are not reported missing in the first week after purchase will not provide free of charge.
13. To enquire about claiming under this warranty, please follow these steps:
- carefully check the operating instructions, user manual and the terms of this warranty;
 - have the model and serial number of the Appliance available;
 - have the proof of purchase (e.g. an invoice) available;
 - telephone the numbers shown below.
14. You accept that if you make a warranty claim, Residentia Group and its ASR may exchange information in relation to you to enable Residentia Group to meet its obligations under this warranty.

IMPORTANT

Before calling for service, please ensure that the steps in point 13 have been followed.

CONTACT SERVICE

→ Service: 1300 11 HELP (4357)

The Australian Consumer Law requires the inclusion of the following statement with this warranty:

Our goods come with guarantees that cannot be excluded under the Australian Consumer Law. You are entitled to a replacement or refund for a major failure and for compensation for any other reasonably foreseeable loss or damage. You are also entitled to have the goods repaired or replaced if the goods fail to be of acceptable quality and the failure does not amount to a major failure.

Warranty (NZ)

NEW ZEALAND WARRANTY TERMS & CONDITIONS COOKING APPLIANCES

To help care for your investment, be sure to register your appliance online. Registration will help you if you need to arrange service in the future, and serves as a record of your purchase—including critical information like model number and serial number – that you can refer to at any time. Simply visit the below website, or ask your retailer for help: www.esatto.house/nz/registration

WARRANTY

These products are covered by a warranty for a period of 24 months from the date of purchase, subject to the following conditions*. The warranty covers rectification free of charge of any fault arising from defective materials or components, or faulty workmanship or assembly.

* The conditions above mentioned are:

1. That the purchaser carefully follows all instructions packed with the product;
2. That the purchaser and/or installer carefully follows the installation instructions provided and complies with electrical wiring regulations, gas and/or plumbing codes;
3. That the purchaser carefully follows instructions provided in the owner's handbook relating to the proper use and care of the product and does not use the product for any purpose other than the domestic use for which it has been designed;
4. Commercial use of the product for professional or industrial purposes will void this warranty;
5. That the product was purchased and installed in New Zealand;
6. That this warranty does not extend to:
 - a) optional glass lids for hobs apart from claims which relate to mechanical or physical damage thereof at the date of purchase;
 - b) 'consumable' parts such as light bulbs or filters;
 - c) damage to ceramic glass caused by liquid or solid spill-overs, lack of maintenance, or impact;
 - d) damage to surface coatings caused by cleaning or maintenance using products not recommended by the owner's handbook;

- e) defects caused by normal wear and tear, accident, negligence, alteration, misuse or incorrect installations;
 - f) a product dismantled, repaired or serviced by any serviceman other than an authorised service agent;
 - g) a product not in possession of the original purchaser;
 - h) damage caused by power outages or surges
 - i) damage caused by pests (eg. rats, cockroaches etc.)
7. That if the product is a freestanding microwave oven or small appliance it must be returned to the dealer/retailer for servicing. These products, unless stated otherwise, have a 12 month warranty from original date of purchase with 24 months on the microwave magnetron; Waste disposers have a 12 month warranty.
 8. The provision of service under this warranty is limited by a 25km boundary from the retailer where the product was purchased except for microwaves. Such travelling outside of these limits will incur commercial cost to be paid by you, regulated by the number of kilometres travelled beyond the 25km limit (50km return trip). Microwaves are to be delivered to the nearest authorised service agent by the customer.

Please refer to your user manual for any further conditions that may apply to your specific model.

Nothing herein contained shall be construed in any way as excluding or limiting your rights under the Consumer Guarantees Acts 1993.

For Service please visit www.applico.co.nz/service or contact the dealer/retailer from whom you purchased the product from or call the 0800 number listed below. If you are unable to establish the date of purchase, or the fault is not covered by this warranty, or if the product is found to be in working order, you will be required to bear all service call charges.

Registration of this warranty constitutes acceptance of the terms and conditions of this warranty.

Should you require any assistance, please call Customer Services on 0800 763 448.

Distributed by Applico Ltd. www.applico.co.nz July 2019

After registering your appliance online, we recommend you fill out the below information for your reference and keep this warranty card in a safe place.



esatto
everything
you need



A RESIDENTIA
GROUP INITIATIVE