

Model/s
EDW606CS

Version
V1.4 1122

Everything you need
for your 60cm
Freestanding Dishwasher
is in this User Manual

esatto

Welcome

Residentia Group

—

Head Office

165 Barkly Avenue
Burnley, Victoria
Australia 3121

—

ACN

600 546 656

—

Online

residentia.group

www.esatto.house

  @esatto.house

—

Postage

PO Box 5177

Burnley, Victoria

Australia 3121

—

Telephone

1300 11 4357

Congratulations on purchasing your new Dishwasher. The Esatto brand is proudly distributed within Australia by Residentia Group Pty Ltd.

Please refer to the warranty card at the rear of this manual for information regarding your product's parts and labour warranty, or visit us online at: www.residentia.group

At Residentia Group, we are customer obsessed and our Support Team are there to ensure you get the most out of your appliance. Should you want to learn more about your new dishwasher, it's features or importantly taking care of the appliance, our Support Team are here to help.

You can use our online Support Centre at anytime by visiting: <http://support.residentia.group.com.au>

Or you can contact us via phone by dialing: 1300 11 HELP (4357).

It is important that you read through the following use and care manual thoroughly to familiarise yourself with the installation and operation requirements of your appliance to ensure optimum performance.

Again, thank you for choosing an Esatto appliance and we look forward to being of service to you.

Kind Regards,
The Residentia Team

Contents

Page 2
Welcome

Page 4
Safety Instructions

Page 5
Your Dishwasher

Page 6
Quick Start Guide

Page 7
Control Panel

Page 8
Installation Instructions

Page 11
**Preparing
& Loading Dishes**

Page 12
**Loading
Recommendations**

Page 13
**Cutlery Rack
Usage Tips**

Page 14
**Rinse Aid
& Detergent**

Page 16
Operation Instructions

Page 18
Basket Tips

Page 19
Cleaning & Maintenance

Page 21
Troubleshooting

Page 24
Technical Information

Page 26
Your Receipt

Page 27
Purchase Details

Page 28
Warranty

Safety Instructions

Warning!

When using your dishwasher, follow the precautions listed below:

- Installation and repair can only be carried out by a qualified technician.
- This appliance is only intended for use indoors only within a domestic environment.
- This appliance is not intended for use by persons (including children) with reduced physical, sensory or mental capabilities, or lack of experience and knowledge, unless they have been given supervision or instruction concerning use of the appliance by a person responsible for their safety.
- Children should be supervised to ensure that they do not play with the appliance.
- If the power cord is in any way damaged it must be replaced by the manufacturer, its service agent or a qualified and licensed electrician.
- To protect against the risk of electrical shock, do not immerse the unit, cord or plug in water or other liquid
- Please unplug before cleaning and performing maintenance on the appliance.
- Use a soft cloth moistened with mild soap, and then use a dry cloth to wipe it again.
- Some dishwasher detergents are strongly alkaline. They can be extremely dangerous if swallowed. Avoid contact with the skin and eyes and keep children away from the dishwasher when the door is open.
- Check that the detergent powder is empty after completion of the wash cycle.
- Do not wash plastic items unless they are marked "dishwasher safe" or the equivalent.
- For unmarked plastic items not so marked, check the manufacturer's recommendations.
- Use only detergent and rinse agents recommended for use in an automatic dishwasher.
- Never use soap, laundry detergent, or hand washing detergent in your dishwasher.
- The door should not be left open, since this could increase the risk of tripping.
- If the supply cord is damaged, it must be replaced by the manufacturer or its service agent or a similarly qualified person in order to avoid a hazard.
- During installation, the power supply must not be excessively or dangerously bent or flattened.
- Do not tamper with controls.
- The appliance needs to be connected to the main water valve using new hose sets. Old sets should not be reused.
- To save energy, in stand by mode, the appliance will switch off automatically while there is no any operation in 30 minutes.

⚡ EARTHING INSTRUCTIONS

- This appliance must be earthed. In the event of a malfunction or breakdown, earthing will reduce the risk of an electric shock by providing a path of least resistance of electric current. This appliance is equipped with an earthing conductor plug.
- The plug must be plugged into an appropriate outlet that is installed and earthed in accordance with all local codes and ordinances.
- Improper connection of the equipment-earthing conductor can result in the risk of an electric shock.
- Check with a qualified electrician or service representative if you are in doubt whether the appliance is properly grounded.
- Do not modify the plug provided with the appliance; If it does not fit the outlet.
- Have a proper outlet installed by a qualified electrician.
- Do not abuse, sit on, or stand on the door or dish rack of the dishwasher.
- Do not operate your dishwasher unless all enclosure panels are properly in place.
- Open the door very carefully if the dishwasher is operating, there is a risk of water squirting out.
- Do not place any heavy objects on or stand on the door when it is open. The appliance could tip forward.
- When loading items to be washed:
 - 1) Locate sharp items so that they are not likely to damage the door seal;
 - 2) Warning: Knives and other utensils with sharp points must be loaded in the basket with their points facing down or placed in a horizontal position.

UNPACKING

- After unpacking, please dispose of all elements of packaging in a way that will not cause damage to the environment.

Caution!

During unpacking, the packaging materials (polythene bags, polystyrene pieces, etc.) should be kept out of reach of children.

DISPOSAL OF THE APPLIANCE

- For disposing of package and the appliance please go to a recycling center. Therefore cut off the power supply cable and make the door closing device unusable. 
- Cardboard packaging is manufactured from recycled paper and should be disposed in the waste paper collection for recycling.
- By ensuring this product is disposed of correctly, you will help prevent potential negative consequences for the environment and human health, which could otherwise be caused by inappropriate waste handling of this product.
- For more detailed information about recycling of this product, please contact your local city office and your household waste disposal service.
- **DISPOSAL:** Do not dispose this product as unsorted municipal waste. Collection of such waste separately for special treatment is necessary.

Your Dishwasher

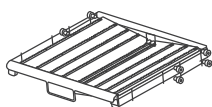
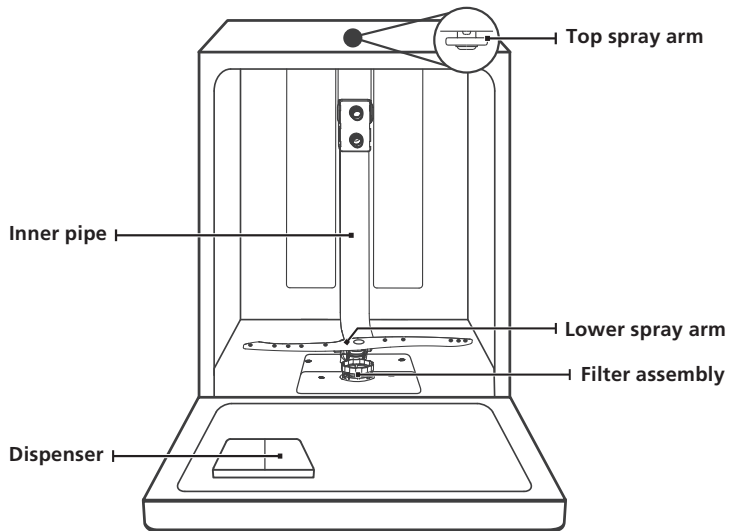

Cutlery rack

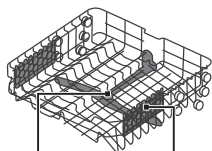

upper spray arm Cup rack
Upper basket

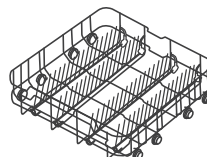

Lower basket

NOTE

Diagrams and pictures in this manual are only for reference, your appliance may appear differently.

Quick Start Guide

Please read the corresponding content in the instruction manual for detailed operating method.

STEP 1:

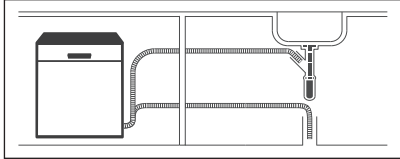

Install the dishwasher. Refer to the Installation Instructions section of this manual.

STEP 2:

Remove any large residue on the dishes.



STEP 3:

Load the dishwasher baskets.

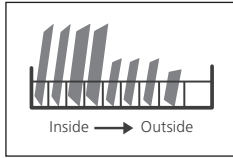

STEP 4:

Fill the dispenser.

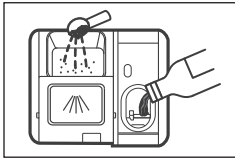

STEP 5:







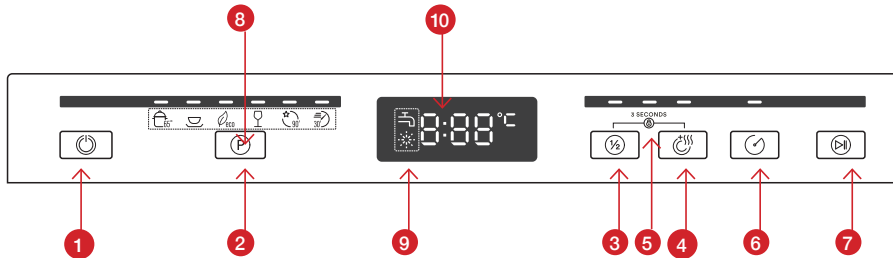

Select a program and any optional settings and then run the dishwasher.



Control Panel



KEY

- | | |
|-----------------------|---|
| 1. Power button | Press this button to turn on your dishwasher, the screen lights up. When pressing this button, corresponding indicator will be lit. |
| 2. Program | Select the appropriate washing program, the selected program indicator will be lit. |
| 3. Half Load | When you have about or less than 6 place setting dishware to wash, you can choose this function to save energy and water (It can only be used with Intensive, Normal, ECO, Glass and 90 min). |
| 4. Extra Drying | For better drying results (It can only be used with Intensive, Normal, ECO, Glass and 90 min). |
| 5. Child lock | This option allows you to lock the buttons on the control panel (except the Power button). To lock or unlock the buttons on the control panel, press and hold the Half-load & Extra drying buttons simultaneously for 3 seconds. When activated, the corresponding indicator will be lit. |
| 6. Delay | Press this button to set the delayed hours for washing. You can delay the start of washing up to 24 hours. One press on this button delays the start of washing by one hour. |
| 7. Start / Pause | To start the selected washing program or pause it when the dishwasher is in operation. |
| 8. Program indicators | <p> Intensive 65° C For heaviest soiled crockery, such as pots, pans, casserole dishes and dishes that have been sitting with dried food on them for some time.</p> <p> Heavy For heavily soiled loads, such as pots, plates, glasses and lightly soiled pans.</p> <p>*  ECO 50° C This program is for normally soiled loads at rated capacity.</p> <p> Glass Suitable for lightly soiled delicate glassware.</p> <p> Super 90' A fast 90 minute daily program for lightly soiled dishes.</p> <p> Quick 30' A quick 30 minute wash suitable for lightly soiled dishes. Doesn't include a drying stage.</p> |
| 9. Warning indicators | <p>Rinse Aid If the “” indicator is lit, the dishwasher is low on dishwasher rinse aid and requires a refill.</p> <p>Water Faucet If the “” indicator is lit, it means the water faucet closed.</p> |
| 10. Display Screen | To show the reminding time, delay time, error code etc. |

*AS/NZS 2007.1: This program is the test cycle.

The information for comparability test in accordance with *AS/NZS 2007.1

Installation Instructions

WARNING:**ELECTRICAL SHOCK HAZARD**

Disconnect electrical power before installing dishwasher. Failure to do so could result in death or electrical shock.

**IMPORTANT!**

The installation of the pipes and electrical equipments should be done by professionals.

POWER CONNECTION**WARNING:**

For your personal safety:

- Do not use an extension cord or an adapter plug with this appliance.
- Do not, under any circumstances, cut or remove the earthing connection from the power cord.

Electrical requirements

Please look at the rating label to know the rating voltage and connect the dishwasher to the appropriate power supply. Use the required fuse 10A/13A/16A, time delay fuse or circuit breaker recommended and provide separate circuit serving only this appliance.

Electrical connection

Ensure the voltage and frequency of the power being corresponds to those on the rating plate. Only insert the plug into an electrical socket which is earthed properly. If the electrical socket to which the appliance must be connected is not appropriate for the plug, replace the socket, rather than using a adapters or the like as they could cause overheating and burns.

Ensure that proper earthing exists before use

WATER SUPPLY AND DRAIN**Cold water connection**

Connect the cold water supply hose to a threaded 3/4 inch connector and make sure that it is fastened tightly in place.

If the water pipes are new or have not been used for an extended period of time, let the water run to make sure that the water is clear. This precaution is needed to avoid the risk of the water inlet to be blocked and damage the appliance.

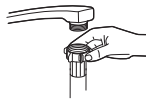

ordinary supply hose

Installation Instructions (Continued)

WARNING:

A hose that attaches to a sink spray can burst if it is installed on the same water line as the dishwasher. If your sink has one, it is recommended that the hose be disconnected and the hole plugged.

DRAIN HOSE CONNECTION

Insert the drain hose into a drain pipe with a minimum diameter of 4 cm, or let it run into the sink, making sure to avoid bending or crimping it. The height of drain pipe must be less than 1000mm. The free end of the hose must not be immersed in water to avoid the back flow of it.

Ensure that the drain hose is securely fixed in either position A or position B.

How to drain excess water from hoses

If the sink is 1000 higher from the floor, the excess water in hoses cannot be drained directly into the sink. It will be necessary to drain excess water from hoses into a bowl or suitable container that is held outside and lower than the sink.

Water outlet

Connect the water drain hose. The drain hose must be correctly fitted to avoid water leaks. Ensure that the water drain hose is not kinked or squashed.

Extension hose

If you need a drain hose extension, make sure to use a similar drain hose. It must be no longer than 4 meters; otherwise the cleaning effect of the dishwasher could be reduced.

Syphon connection

The waste connection must be at a height less than 100 cm (maximum) from the bottom of the dish. The water drain hose should be fixed.

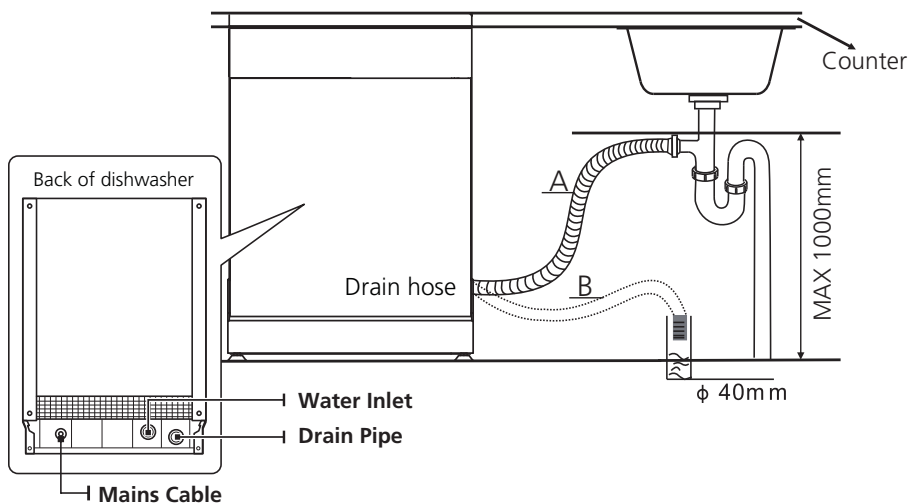

Installation Instructions (Continued)

POSITIONING THE APPLIANCE

Position the appliance in the desired location. The back should rest against the wall behind it, and the sides, along the adjacent cabinets or walls. The dishwasher is equipped with water supply and drain hoses that can be positioned either to the right or the left sides to facilitate proper installation.

Levelling the appliance

Once the appliance is positioned for levelling, the height of the dishwasher may be altered via adjustment of the screwing level of the feet. In any case, the appliance should not be inclined more than 2°.

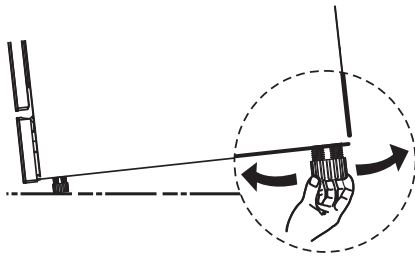

FREESTANDING INSTALLATION

Fitting between existing cabinets

The height of the dishwasher, 845 mm, has been designed in order to allow the machine to be fitted between existing cabinets of the same height in modern fitted kitchens. The feet can be adjusted so that correct height is reached.

The laminated top of the machine does not require any particular care since it is heatproof, scratch proof and stain proof.

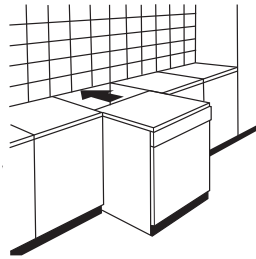

Fitting underneath a bench top

In most modern fitted kitchens there is only one single work top under which cabinets and electrical appliances are fitted. In this case remove the work top of the dishwasher by unscrewing the screws under the rear edge of the top (a).

ATTENTION:

After removing the work top, the screws must be screwed again under the rear edge of the top (b).

The height will then be reduced to 815 mm, as scheduled by the International Regulations (ISO) and the dishwasher will fit perfectly under the kitchen working top

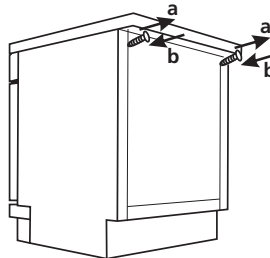

Preparing & Loading Dishes

- Consider buying utensils which are identified as dishwasher-proof.
- For particular items, select a program with the lowest possible temperature.
- To prevent damage, do not take glass and cutlery out of the dishwasher immediately after the program has ended.

CUTLERY/DISHES SUITABILITY

The following are not suitable

- Cutlery with wooden, horn china or mother-of-pearl handles
- Plastic items that are not heat resistant
- Older cutlery with glued parts that are not temperature resistant
- Bonded cutlery items or dishes
- Pewter or cooper items
- Crystal glass
- Steel items subject to rusting
- Wooden platters
- Items made from synthetic fibers

The following are of limited suitability

- Some types of glasses can become dull after a large number of washes
- Silver and aluminum parts have a tendency to discolour during washing
- Glazed patterns may fade if machine washed frequently

RECOMMENDATIONS FOR LOADING THE DISHWASHER

Scrape off any large amounts of leftover food. Soften remnants of burnt food in pans. It is not necessary to rinse the dishes under running water.

For best performance of the dishwasher, follow these loading guidelines.

- Items such as cups, glasses, pots/pans, etc. are faced downwards.
- Curved items, or ones with recesses, should be loaded aslant so that water can run off.
- All utensils are stacked securely and can not tip over.
- All utensils are placed in the way that the spray arms can rotate freely during washing.
- Load hollow items such as cups, glasses, pans etc. With the opening facing downwards so that water cannot collect in the container or a deep base.
- Dishes and items of cutlery must not lie inside one another, or cover each other.
- To avoid damage, glasses should not touch one another.
- The upper basket is designed to hold more delicate and lighter dishware such as glasses, coffee and tea cups.

- Long bladed knives stored in an upright position are a potential hazard!
- Long and / or sharp items of cutlery such as carving knives must be positioned horizontally in the upper basket.
- Please do not overload your dishwasher. This is important for good results and for reasonable consumption of energy.

NOTE: Very small items should not be washed in the dishwasher as they could easily fall out of the basket.

Removing the dishes

To prevent water dripping from the upper basket into the lower basket, we recommend that you empty the lower basket first, followed by the upper basket.

WARNING

Items will be hot! To prevent damage, do not take glass and cutlery out of the dishwasher for around 15 minutes after the program has ended.



Loading the upper basket

The upper basket is designed to hold more delicate and lighter dishware such as glasses, coffee and tea cups and saucers, as well as plates, small bowls and shallow pans (as long as they are not too dirty). Position the dishes and cookware so that they will not get moved by the spray of water.



Loading the lower basket

We suggest that you place large items and the most difficult to clean items are to be placed into the lower basket: such as pots, pans, lids, serving dishes and bowls, as shown in the figure below. It is preferable to place serving dishes and lids on the side of the racks in order to avoid blocking the rotation of the top spray arm.

The maximum diameter advised for plates in front of the detergent dispenser is of 19 cm, this not to hamper the opening of it.



Loading the cutlery basket

Cutlery should be placed in the cutlery rack separately from each other in the appropriate positions, and do make sure the utensils do not nest together, this may cause bad performance.

WARNING

Do not let any item extend through the bottom. Always load sharp utensils with the sharp end downwards!



NOTE:

For the best washing effect, please load the baskets referred in the Loading Recommendations section.

Loading Recommendation

Loading the baskets according to AS/NZS 2007.1:

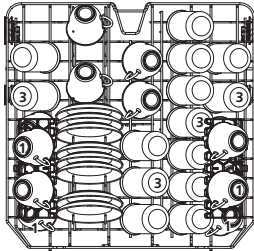

| Number | Item |
|--------|---------|
| 1 | Cups |
| 2 | Saucers |
| 3 | Glasses |

1. UPPER BASKET

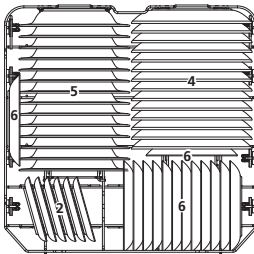

| Number | Item |
|--------|----------------|
| 4 | Dinner plates |
| 5 | Soup plates |
| 6 | Dessert dishes |

2. LOWER BASKET

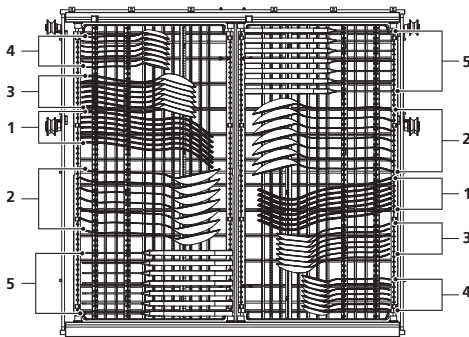

| Number | Item |
|--------|----------------|
| 1 | Forks |
| 2 | Soup spoons |
| 3 | Dessert spoons |
| 4 | Teaspoons |
| 5 | Knives |



3. CUTLERY BASKET

Information for comparability tests in accordance with (*AS/NZS 2007.1)

Capacity: 14 place settings

Position of the upper basket: lower position

Program: ECO

Rinse aid setting: 6

Detergent (Pre/main): 5g/27.5g

Door is open at the end of the drying cycle for the drying performance test (Door position: Open 50 mm)

Cutlery Rack Usage Tips

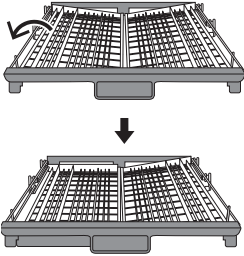

Lift the left basket up, adjust it to lower position, left basket is flat and right basket is sidelining.

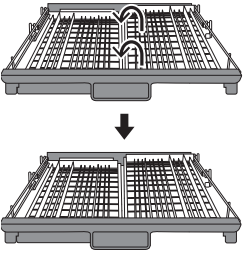

Lift the right basket up, both left and right baskets are flat.

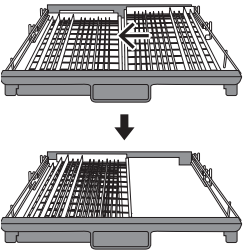

Move the right basket from right to left, two basket are overlapping.

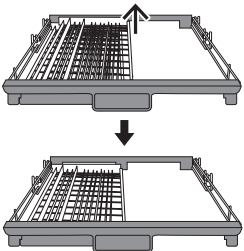

Remove the right basket from the tray, only has the left basket.

Rinse Aid & Detergent

The rinse aid is released during the final rinse to prevent water from forming droplets on your dishes, which can leave spots and streaks. It also improves drying by allowing water to roll off the dishes. Your dishwasher is designed to use liquid rinse aids.

WARNING

Only use branded rinse aid for dishwasher. Never fill the rinse aid dispenser with any other substances (e.g. Dishwasher cleaning agent, liquid detergent). This would damage the appliance.

When to refill the rinse aid

The regularity of the dispenser needing to be refilled depends on how often dishes are washed and the rinse aid setting used.

- The Low Rinse Aid indicator (✱) will appear in the display when more rinse aid is needed.
- Do not overfill the rinse aid dispenser.

Function of detergent

The chemical ingredients that compose the detergent are necessary to remove, crush and disperse all dirt out of the dishwasher. Most of the commercial quality detergents are suitable for this purpose.

WARNING

- **Proper Use of Detergent**
Use only detergent specifically made for dishwashers use. Keep your detergent fresh and dry.
- Don't put powdered detergent into the dispenser until you are ready to wash dishes.
- **Dishwasher detergent is corrosive! Keep dishwasher detergent out of the reach of children**



FILLING THE RINSE AID COMPARTMENT

STEP 1:

Remove the rinse aid compartment cap by lifting up the handle.

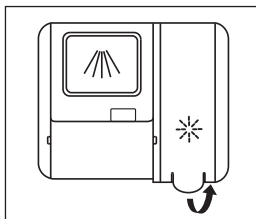

STEP 2:

Pour the rinse aid into the dispenser, being careful not to overflow.

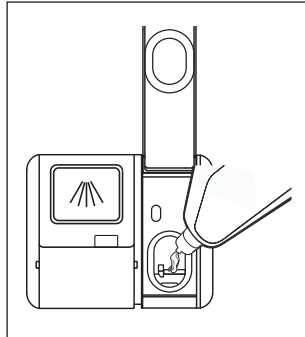

STEP 3:

Close the cap when done.

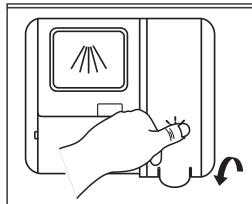

Adjusting the rinse aid compartment

To achieve a better drying performance with limited rinse aid, the dishwasher is designed to adjust the consumption by user. Follow the below steps.

1. Switch on the appliance.
2. Within 60 seconds after step 1, press the Start/ Pause button more than 5 seconds to enter the set model, the rinse aid indication blinks.
3. Press the Program button to select the proper set according to your using habits, the sets will change in the following sequence: D1, D2, D3, D4, D5, D1. The higher the number, the more rinse aid the dishwasher uses.
4. Without operation in 5 seconds or press the Power button to exit the set model, the set success.

Rinse Aid & Detergent (Continued)

Filling The Detergent Dispenser

STEP 1:

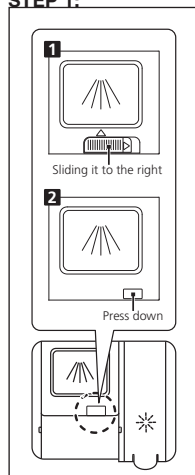

Please choose an opening according to your requirements.

1. Open the cap by sliding the release catch.
2. Open the cap by pressing down the release catch.

STEP 2:

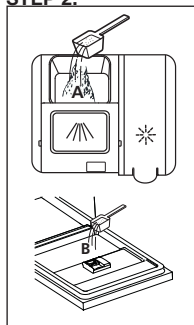

Add detergent into the larger cavity (A) for the main wash cycle. For better cleaning result, especially if you have very dirt items, pour a small amount of detergent onto the door. The additional detergent will activate during the pre-wash phase.

STEP 3:

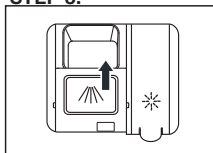

Close the flap by sliding it to the front and then pressing it down.

NOTE







- Be aware that depending on the soiling of water, setting may be different.
- Please observe the manufacturer's recommendations on the detergent packaging.

Operation Instructions

WASH CYCLE TABLE

The table below shows which programs are best for the levels of food residue on them and how much detergent is needed. It also show various information about the programs.

(●) Rinse Aid required

| Program | Description Of Cycle | Detergent Pre/Main | Running Time(min) | Energy (Kwh) | Water (L) | Rinse Aid |
|---|---|-----------------------------------|-------------------|--------------|-----------|-----------|
| Intensive 65° C  | Pre-wash(50°C) Wash(60°C) Rinse Rinse Rinse(65°C) Drying | $\frac{5}{28.7g}$ (Or All in1) | 170 | 1.5 | 17.5 | ● |
| Heavy  | Pre-wash(45°C) Wash(55°C) Rinse Rinse (65°C) Drying | $\frac{5}{28.7g}$ (Or All in1) | 160 | 1.3 | 13.5 | ● |
| * ECO 50° C  | Wash (50°C) Rinse Rinse(45°C) Drying | $\frac{5}{28.7g}$ (Or All in1) | 190 | 0.75 | 12.7 | ● |
| Glass  | Pre-wash Wash(42°C) Rinse Rinse(60°C) Drying | $\frac{5}{28.7g}$ (Or All in1) | 125 | 0.8 | 13 | ● |
| Super 90'  | Wash(65°C) Rinse Rinse(65°C) Drying | $\frac{25g}{}$ (Or All in1) | 90 | 1.2 | 11.5 | ● |
| Quick 30'  | Wash(40°C) Rinse Rinse(45°C) | 25g | 30 | 0.6 | 11.5 | ○ |

NOTE:

*AS/NZS 2007.1: This is the program for a normally soiled load at rated capacity. This program is the test cycle. The information for comparability test in accordance with *AS/NZS 2007.1.

Operation Instructions (Continued)

STARTING A CYCLE WASH

1. Draw out the lower and upper basket, load the dishes and push them back. It is recommended to load the lower basket first, then the upper one.
2. Pour in the detergent.
3. Insert the plug into the socket. The Power supply refer to the Technical Specifications section.
4. Make sure that the water supply is turned on to full pressure.
5. Close the door, press the Power button, to switch on the machine.
6. Choose a program, the response light will turn on. Then press the Start/Pause button, the dishwasher will start its cycle.

CHANGING THE PROGRAM MID-CYCLE

A wash cycle can only be changed if it has been running for a short time otherwise, the detergent may have already been released and the dishwasher may have already drained the wash water. If this is the case, the dishwasher needs to be reset and the detergent dispenser must be refilled. To reset the dishwasher, follow the instructions below:

1. Press the Start/Pause button to pause the washing.
2. Press program button for more than 3 seconds. The program will cancel.
3. Press the program button to select the desired program.
4. Press the Start/Pause button, after 10 seconds, the dishwasher will start.

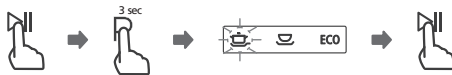

ADDING A DISH MID-CYCLE

A forgotten dish can be added any time before the detergent dispenser opens. If this is the case, follow the instructions below:

1. Press the Start/Pause button to pause the washing.
2. Wait 5 seconds then open the door.
3. Add the forgotten dishes.
4. Close the door.
5. Press the Start/Pause button after 10 seconds, the dishwasher will start.

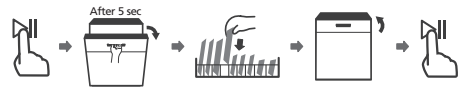

WARNING

It is dangerous to open the door mid-cycle, as hot steam may scald you.

Basket Tips

ADJUSTING THE UPPER BASKET

The height of the upper basket can be easily adjusted to accommodate taller dishes in either the upper or lower basket.

To adjust the height of the upper rack, follow these steps:

STEP 1:
Pull out the upper basket.

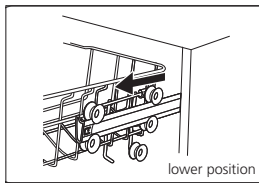

STEP 2:
Remove the upper basket.

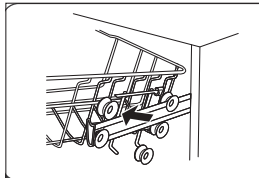

STEP 3:
Re-attach the upper basket to upper or lower rollers.

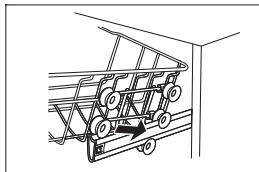

STEP 4:
Push in the upper basket.

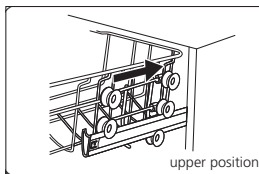

FOLDING BACK THE CUP SHELVES

To make room for taller items in the upper basket, raise the cup rack upwards. You can then lean the tall glasses against it. You can also remove it when it is not required for use.

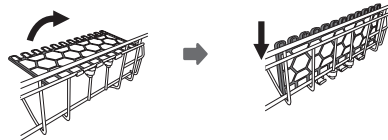

FOLDING BACK THE RACK SHELVES

The spikes of the lower basket are used for holding plates and a platter. They can be lowered to make more room for large items.

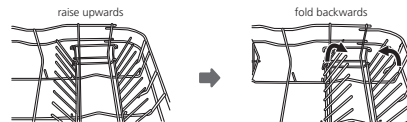

Cleaning & Maintenance

EXTERNAL CARE

The door and the door seal

Clean the door seals regularly with a soft damp cloth to remove food deposits. When the dishwasher is being loaded, food and drink residues may drip onto the sides of the dishwasher door. These surfaces are outside the wash cabinet and are not accessed by water from the spray arms. Any deposits should be wiped off before the door is closed.

The control panel

If cleaning is required, the control panel should be wiped with a soft damp cloth only.

WARNING

- To avoid penetration of water into the door lock and electrical components, do not use a spray cleaner of any kind.
- Never use abrasive cleaners or scouring pads on the outer surfaces because they may scratch the finish. Some paper towels may also scratch or leave marks on the surface.

INTERNAL CARE

Filtering System

The filtering system in the base of the wash cabinet retains coarse debris from the washing cycle. The collected coarse debris may cause the filters to clog. Check the condition of the filters regularly and clean them if necessary under running water. Refer to the following steps to clean the filters in the wash cabinet.

NOTE

Diagrams and pictures in this manual are only for reference, the filtering system and spray arms may appear differently.

STEP 1:

Hold the coarse filter and rotate it anticlockwise to unlock the filter. Lift the filter upwards and out of the dishwasher.

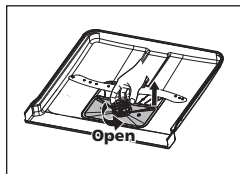

STEP 2:

The fine filter can be pulled off the bottom of the filter assembly. The coarse filter can be detached from the main filter by gently squeezing the tabs at the top and pulling it away.

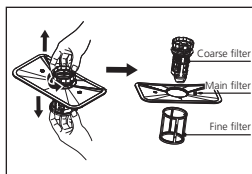

STEP 3:

Larger food remnants can be cleaned by rinsing the filter under running water. For a more thorough clean, use a soft cleaning brush.

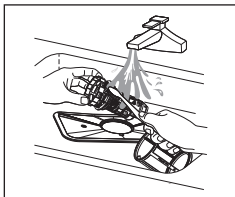

STEP 4:

Reassemble the filters in the reverse order of the disassembly, replace the filter insert, and rotate clockwise to the close arrow.

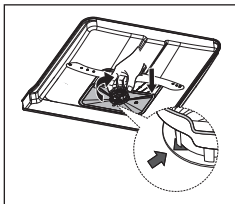

WARNING

- Do not over tighten the filters. Put the filters back in sequence securely, otherwise coarse debris could get into the system and cause a blockage.
- Never use the dishwasher without filters in place. Improper replacement of the filter may reduce the performance level of the appliance and damage dishes and utensils.

Cleaning & Maintenance (Continued)

SPRAY ARMS

It is necessary to clean the spray arms regularly for hard water chemicals will clog the spray arm jets and bearings.

To clean the spray arms, follow the instructions below:

STEP 1:

To remove the upper spray arm, hold the nut in the center still and rotate the spray arm counterclockwise to remove it.

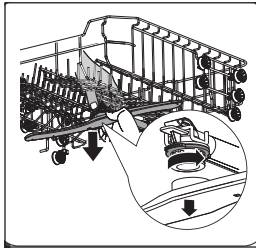

STEP 2:

To remove the lower spray arm, pull out the spray arm upward.

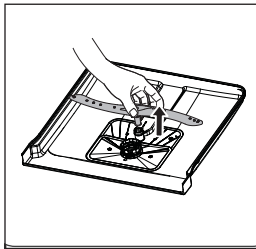

STEP 3:

Wash the arms in soapy and warm water and use a soft brush to clean the jets. Replace them after rinsing them thoroughly.

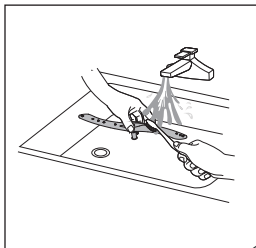

CARING FOR THE DISHWASHER

Frost precaution

Please take frost protection measures on the dishwasher in winter. Every time after washing cycles, please operate as follows:

1. Cut off the electrical power to the dishwasher at the supply source.
2. Turn off the water supply and disconnect the water inlet pipe from the water valve.
3. Drain the water from the inlet pipe and water valve. (Use a pan to gather the water)
4. Reconnect the water inlet pipe to the water valve.
5. Remove the filter at the bottom of the tub and use a sponge to soak up water in the sump.

After every wash

After every wash, turn off the water supply to the appliance and leave the door slightly open so that moisture and odors are not trapped inside.

Remove the plug

Before cleaning or performing maintenance, always remove the plug from the socket.

No solvents or abrasive cleaning

To clean the exterior and rubber parts of the dishwasher, do not use solvents or abrasive cleaning products. Only use a cloth with warm soapy water. To remove spots or stains from the surface of the interior, use a cloth dampened with water and a little vinegar, or a cleaning product made specifically for dishwashers.

After prolonged inactivity

It is recommended that you run a wash cycle with the dishwasher empty and then remove the plug from the socket, turn off the water supply and leave the door of the appliance slightly open. This will help the door seals to last longer and prevent odours from forming within the appliance.

Moving the appliance

If the appliance must be moved, try to keep it in the vertical position. If absolutely necessary, it can be positioned on its back.

Seals

One of the factors that cause odours to form in the dishwasher is food that remains trapped in the seals. Periodic cleaning with a damp sponge will prevent this from occurring.

Troubleshooting

OPERATION IN CASE OF EMERGENCY

In the event of an emergency you should:

- Switch off the appliance using the Power button
- Switch the clothes dryer off at the power point and unplug the unit. If the power point isn't accessible, switch the relevant circuit off at your fuse box/switch board.
- Call our support team on 1300 334 357.

ERROR CODES

If there is a malfunction, the dishwasher will display error codes to identify these.

| Error Code | Description | Cause |
|------------|---|---|
| E1 | Longer inlet time | Faucets is not opened, or water intake is restricted, or water pressure is too low. |
| E3 | Not reaching required temperature. | Malfunction of heating element. |
| E4 | Overflow. | Some element of dishwasher leaks. |
| Ed | Failure of communication between main PCB with display PCB. | Open circuit or break wiring for the communication. |

WARNING

- If overflow occurs, turn off the main water supply before calling a service.
- If there is water in the base pan because of an overflow or small leak, the water should be removed before restarting the dishwasher.

FURTHER PROBLEM SOLVING

Before calling for service, review the following:

| Issue | Possible cause | What to do |
|----------------------------------|--|--|
| Dishwasher will not start | <ul style="list-style-type: none"> • Fuse blown, or the circuit break tripped. • Power supply is not turned on. • Water pressure is low • Door of dishwasher not properly closed | <ul style="list-style-type: none"> • Replace fuse or reset circuit breaker. Remove any other appliances sharing the same circuit with the dishwasher. • Make sure the dishwasher is turned on and the door is closed securely. Make sure the power cord is properly plugged into the wall socket. • Check that the water supply is connected properly and the water is turned on. • Make sure to close the door properly and latch it. |
| Water not pumped from dishwasher | <ul style="list-style-type: none"> • Twisted or trapped drain hose. • Filter clogged. • Kitchen sink clogged. | <ul style="list-style-type: none"> • Check the drain hose. • Check coarse the filter. • Check the kitchen sink to make sure it is draining well. If the problem is the kitchen sink that is not draining, you may need a plumber rather than a serviceman for dishwashers. |

Troubleshooting (Continued)

| Issue | Possible cause | What to do |
|-----------------------------------|---|--|
| Suds in the tub | <ul style="list-style-type: none"> • Wrong detergent. • Spilled rinse-aid. | <ul style="list-style-type: none"> • Use only the special dishwasher detergent to avoid suds. If this occurs, open the dishwasher and let suds evaporate. Add 1 gallon of cold water to the bottom of the dishwasher. Close the dishwasher door, then select any cycle. Initially, the dishwasher will drain out the water. Open the door after draining stage is complete and check if the suds have disappeared. Repeat if necessary. • Always wipe up rinse-aid spills immediately. |
| Stained tub interior | Detergent with colourant may have been used. | Make sure that the detergent has no colourant. |
| White film on inside surface | Hard water minerals. | To clean the interior, use a damp sponge with dishwasher detergent and wear rubber gloves. Never use any other cleaner than dishwasher detergent otherwise, it may cause foaming or suds. |
| There are rust stains on cutlery | The affected items are not corrosion resistant. | The items should be corrosion resistant. |
| Knocking noise in the dishwasher | A spray arm is knocking against an item in a basket | Interrupt the program and rearrange the items which are obstructing the spray arm. |
| Rattling noise in the dishwasher | Items of crockery are loose in the dishwasher. | Interrupt the program and rearrange the items of crockery. |
| Knocking noise in the water pipes | This may be caused by on-site installation or the cross-section of the piping. | This has no influence on the dishwasher function. If in doubt, contact a qualified plumber. |
| The dishes are not clean | <ul style="list-style-type: none"> • The dishes were not loaded correctly. • The program was not powerful enough. • Not enough detergent was dispensed. • Items are blocking the movement of the spray arms. • The filter combination is not clean or is not correctly fitted in the base of wash cabinet. This may cause the spray arm jets to get blocked. | <ul style="list-style-type: none"> • See notes in "Preparing & Loading Dishes". • Select a more intensive program. • Use more detergent, or change your detergent. • Rearrange the items so that the spray can rotate freely. • Clean and/or fit the filter correctly. • Clean the spray arm jets. |
| Cloudiness on glassware. | Combination of soft water and too much detergent. | Use less detergent if you have soft water and select a shorter cycle to wash the glassware and to get them clean. |
| Black or grey marks on dishes | Aluminium utensils have rubbed against dishes | Use a mild abrasive cleaner to eliminate those marks. |

Troubleshooting (Continued)

FURTHER PROBLEM SOLVING CONTINUED

| Issue | Possible cause | What to do |
|-----------------------------|---|---|
| Detergent left in dispenser | Dishes block detergent dispenser | Re-loading the dishes properly. |
| The dishes aren't drying | <ul style="list-style-type: none"> • Improper loading • Too little rinse-aid • Dishes are removed too soon • Wrong program has been selected. • Use of cutlery with a low-quality coating. | <ul style="list-style-type: none"> • Load the dishwasher as suggested in the directions. • Increase the amount of rinse-aid/refill the rinse-aid dispenser. • Do not empty your dishwasher immediately after washing. Open the door slightly so that the steam can come out. Take out the dishes until the inside temperature is safe to touch. Unload the lower basket first to prevent the dropping water from the upper basket. • With a short program, the washing temperature is lower, decreasing cleaning performance. Choose a program with a long washing time. • Water drainage is more difficult with these items. Cutlery or dishes of this type are not suitable for washing in the dishwasher. |

Technical Information

DIMENSIONS

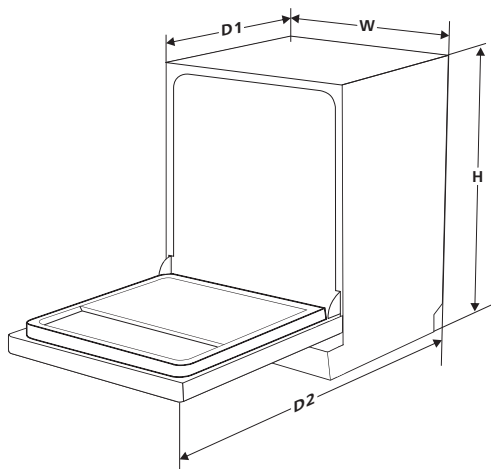

| | |
|-------------------|------------------------------------|
| Height (H) | 845mm |
| Width (W) | 598mm |
| Depth (D1) | 600mm (with the door closed) |
| Depth (D2) | 1175mm (with the door opened 90°) |

RATING LABEL

60cm Freestanding Dishwasher
Model: EDW606CS

esatto

Capacity: 15 Settings
 Rated Voltage: 220-240V~ 50Hz
 Rated Power: 1760-2100W
 Water Pressure: 0.04-1.00MPa
 SAA-171410-EA IPX1
 Made in China



Technical Information (Continued)

TECHNICAL SPECIFICATIONS

| | | |
|---|-------------------------|-----|
| Manufacturer | Esatto | |
| Type/Description | EDW606CS | |
| Standard place settings | 15 | |
| Energy efficiency class | ★ ★ ★ ☆ ☆ ☆ | 3.5 |
| Water consumption class | ★ ★ ★ ★ ☆ ☆ | 4.5 |
| Standard cleaning cycle | ECO | |
| Energy consumption of the standard cleaning cycle | 0.75 kWh | |
| Water consumption of the standard cleaning cycle | 12.7 liter | |
| Program duration of the standard cleaning cycle | 190 mins | |
| Noise level | 49 dB(A) re 1 pW | |
| Mounting | Free standing | |
| Could be built-in | YES | |
| Power consumption | 1760-2100W | |
| Rated voltage/frequency | AC 220-240 V/50 Hz | |
| Water supply pressure | 0.04-1.0 MPa=0.4-10 bar | |

**Attach your receipt
to this page**



Purchase Details

For your records, please record details of your purchase below and staple your receipt on the opposite page. Your serial number can be found on the rating plate of your Dishwasher.

STORE DETAILS

STORE NAME |

ADDRESS |

TELEPHONE |

PURCHASE DATE |

PRODUCT DETAILS

MODEL NO. |

SERIAL NO.* |

Warranty

WARRANTY TERMS AND CONDITIONS DISHWASHERS

This document sets out the terms and conditions of the product warranties for Residentia Group Appliances. It is an important document. Please keep it with your proof of purchase documents in a safe place for future reference should you require service for your Appliance.

1. **IN THIS WARRANTY**
 - (a) 'acceptable quality' as referred to in clause 10 of this warranty has the same meaning referred to in the ACL;
 - (b) 'ACL' means Trade Practices Amendment (Australian Consumer Law) Act (No.2) 2010;
 - (c) 'Appliance' means any Residentia Group product purchased by you accompanied by this document;
 - (d) 'ASR' means Residentia Group authorised service representative;
 - (e) 'Residentia Group' means Residentia Group Pty Ltd of 165 Barkly Ave, Burnley VIC 3121, ACN 600 546 656 in respect of Appliances purchased in Australia;
 - (f) 'major failure' as referred to in clause 10 of this warranty has the same meaning referred to in the ACL and includes a situation when an Appliance cannot be repaired or it is uneconomic for Residentia Group, at its discretion, to repair an Appliance during the Warranty Period;
 - (g) 'Warranty Period' means:
 - (i) where the Appliance is used for personal, domestic or household use (i.e. normal single family use) as set out in the instruction manual, the Appliance is warranted against manufacturing defects for 24 months, following the date of original purchase of the Appliance;
 - (h) 'you' means the purchaser of the Appliance not having purchased the Appliance for re-sale, and 'your' has a corresponding meaning.
2. This warranty only applies to Appliances purchased and used in Australia and is in addition to (and does not exclude, restrict, or modify in any way) any non-excludable statutory warranties in Australia.
3. During the Warranty Period Residentia Group or its ASR will, at no extra charge if your Appliance is readily accessible for service, without special equipment and subject to these terms and conditions, repair or replace any parts which it considers to be defective. Residentia Group or its ASR may use remanufactured parts to repair your Appliance. You agree that any replaced Appliances or parts become the property of Residentia Group. This warranty does not apply to light globes, batteries, filters, seals or similar perishable parts.
4. Parts and Appliances not supplied by Residentia Group are not covered by this warranty.

5. You will bear the cost of transportation, travel and delivery of the Appliance to and from Residentia Group or its ASR. If you reside outside of the service area, you will bear the cost of:
 - (a) travel of an authorised representative;
 - (b) transportation and delivery of the Appliance to and from Residentia Group or its ASR, in all instances, unless the Appliance is transported by Residentia Group or its ASR, the Appliance is transported at the owner's cost and risk while in transit to and from Residentia Group or its ASR.
6. Proof of purchase is required before you can make a claim under this warranty.
7. You may not make a claim under this warranty unless the defect claimed is due to faulty or defective parts or workmanship. Residentia Group is not liable in the following situations (which are not exhaustive):
 - (a) the Appliance is damaged by:
 - (i) accident
 - (ii) misuse or abuse, including failure to properly maintain or service
 - (iii) normal wear and tear
 - (iv) power surges, electrical storm damage or incorrect power supply
 - (v) incomplete or improper installation
 - (vi) incorrect, improper or inappropriate operation
 - (vii) insect or vermin infestation
 - (viii) failure to comply with any additional instructions supplied with the Appliance;
 - (b) the Appliance is modified without authority from Residentia Group in writing;
 - (c) the Appliance's serial number or warranty seal has been removed or defaced;
 - (d) the Appliance was serviced or repaired by anyone other than Residentia Group, an authorised repairer or ASR.
8. This warranty, the contract to which it relates and the relationship between you and Residentia Group are governed by the law applicable where the Appliance was purchased.
9. To the extent permitted by law, Residentia Group excludes all warranties and liabilities (other than as contained in this document) including liability for any loss or damage whether direct or indirect arising from your purchase, use or non use of the Appliance.
10. For Appliances and services provided by Residentia Group in Australia, the Appliances come with a guarantee by Residentia Group that cannot be excluded under the Australian Consumer Law. You are entitled to a replacement or refund for a major failure and for compensation for any other reasonably foreseeable loss or damage. You are also entitled to have the Appliance repaired or replaced if the Appliance fails to be of acceptable quality and the failure does not amount to a major failure. The benefits to you given by this warranty are in addition to your other rights and remedies under a law in relation to the Appliances or services to which the warranty relates.
11. At all times during the Warranty Period, Residentia Group shall, at its discretion, determine whether repair, replacement or refund will apply if an Appliance has a valid warranty claim applicable to it.
12. Missing parts are not covered by warranty. Residentia Group reserves the right to assess each request for missing parts in a case by case basis. Any parts that are not reported missing in the first week after purchase will not provide free of charge.
13. To enquire about claiming under this warranty, please follow these steps:
 - (a) carefully check the operating instructions, user manual and the terms of this warranty;
 - (b) have the model and serial number of the Appliance available;
 - (c) have the proof of purchase (e.g. an invoice) available;
 - (d) telephone the numbers shown below.
14. You accept that if you make a warranty claim, Residentia Group and its ASR may exchange information in relation to you to enable Residentia Group to meet its obligations under this warranty.

IMPORTANT

Before calling for service, please ensure that the steps in point 13 have been followed.

CONTACT SERVICE

→ Service: 1300 11 HELP (4357)

The Australian Consumer Law requires the inclusion of the following statement with this warranty:

Our goods come with guarantees that cannot be excluded under the Australian Consumer Law. You are entitled to a replacement or refund for a major failure and for compensation for any other reasonably foreseeable loss or damage. You are also entitled to have the goods repaired or replaced if the goods fail to be of acceptable quality and the failure does not amount to a major failure.

Warranty (NZ)

NEW ZEALAND WARRANTY TERMS & CONDITIONS DISHWASHER APPLIANCES

To help care for your investment, be sure to register your appliance online. Registration will help you if you need to arrange service in the future, and serves as a record of your purchase—including critical information like model number and serial number – that you can refer to at any time. Simply visit the below website, or ask your retailer for help: www.esatto.house/nz/registration

WARRANTY

These products are covered by a warranty for a period of 24 months from the date of purchase, subject to the following conditions*. The warranty covers rectification free of charge of any fault arising from defective materials or components, or faulty workmanship or assembly.

* The conditions above mentioned are:

1. That the purchaser carefully follows all instructions packed with the product;
 2. That the purchaser and/or installer carefully follows the installation instructions provided and complies with electrical wiring regulations, gas and/or plumbing codes;
 3. That the purchaser carefully follows instructions provided in the owner's handbook relating to the proper use and care of the product and does not use the product for any purpose other than the domestic use for which it has been designed;
 4. Commercial use of the product for professional or industrial purposes will void this warranty;
 5. That the product was purchased and installed in New Zealand;
 6. That this warranty does not extend to:
 - a) optional glass lids for hobs apart from claims which relate to mechanical or physical damage thereof at the date of purchase;
 - b) 'consumable' parts such as light bulbs or filters;
 - c) damage to ceramic glass caused by liquid or solid spill-overs, lack of maintenance, or impact;
 - d) damage to surface coatings caused by cleaning or maintenance using products not recommended by the owner's handbook;
 - e) defects caused by normal wear and tear, accident, negligence, alteration, misuse or incorrect installations;
 - f) a product dismantled, repaired or serviced by any serviceman other than an authorised service agent;
 - g) a product not in possession of the original purchaser;
 - h) damage caused by power outages or surges
 - i) damage caused by pests (eg. rats, cockroaches etc.)
7. That if the product is a freestanding microwave oven or small appliance it must be returned to the dealer/retailer for servicing. These products, unless stated otherwise, have a 12 month warranty from original date of purchase with 24 months on the microwave magnetron; Waste disposers have a 12 month warranty.
 8. The provision of service under this warranty is limited by a 25km boundary from the retailer where the product was purchased except for microwaves. Such travelling outside of these limits will incur commercial cost to be paid by you, regulated by the number of kilometres travelled beyond the 25km limit (50km return trip). Microwaves are to be delivered to the nearest authorised service agent by the customer.

Please refer to your user manual for any further conditions that may apply to your specific model.

Nothing herein contained shall be construed in any way as excluding or limiting your rights under the Consumer Guarantees Acts 1993.

For Service please visit www.applico.co.nz/service or contact the dealer/retailer from whom you purchased the product from or call the 0800 number listed below. If you are unable to establish the date of purchase, or the fault is not covered by this warranty, or if the product is found to be in working order, you will be required to bear all service call charges.

Registration of this warranty constitutes acceptance of the terms and conditions of this warranty.

Should you require any assistance, please call Customer Services on 0800 763 448.

Distributed by Applico Ltd. www.applico.co.nz July 2019

After registering your appliance online, we recommend you fill out the below information for your reference and keep this warranty card in a safe place.



E2447

esatto
everything
you need



A RESIDENTIA
GROUP INITIATIVE