

Model Code/s:

ETM207X
ETM207W
ETM239X
ETM239W
ETM268X
ETM268W

Product:

Top Mount
Refrigerator

Document:

User Manual

Esatto

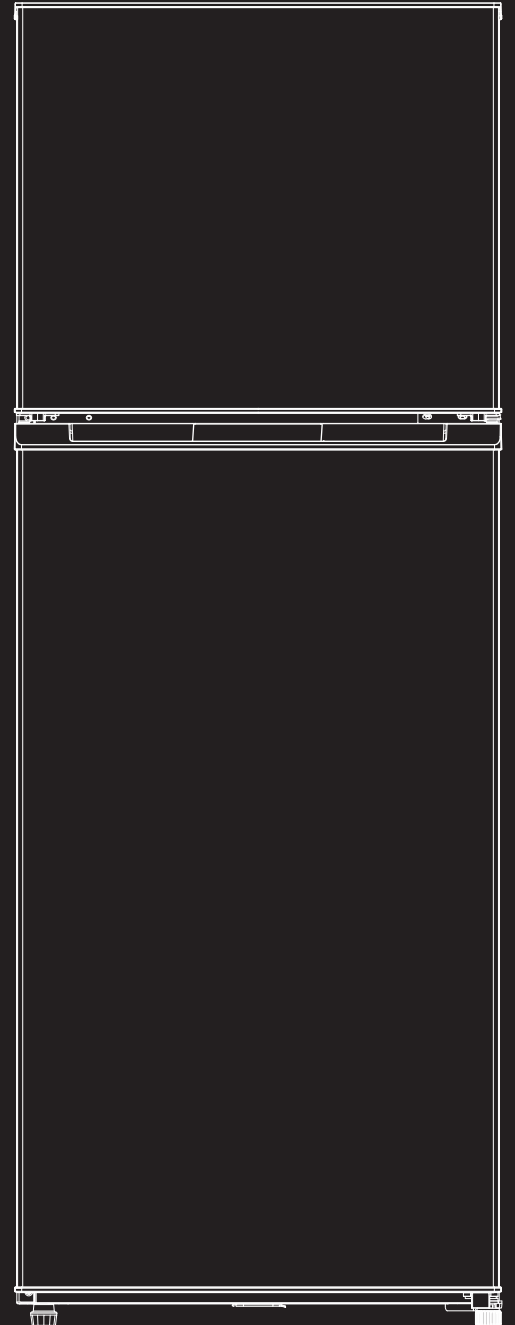

Dear Customer,

Congratulations on purchasing your new refrigerator. The *Esatto* brand is proudly distributed within Australia by Residentia Group Pty Ltd.

Please refer to the warranty card at the rear of this manual for information regarding your product's parts and labour warranty, or visit us online at www.residentiagroup.com.au.

At Residentia Group, we are customer obsessed and our Support Team are there to ensure you get the most out of your appliance. Should you want to learn more about your refrigerator such as temperature settings and importantly taking care of it when cleaning, our Support Team are here to help. You can use our online Support Centre at anytime by visiting <http://support.residentiagroup.com.au>, or you can contact us via phone by dialling: 1300 11 HELP (4357).

It is important that you read through the following use and care manual thoroughly to familiarise yourself with the installation and operation requirements of your appliance to ensure optimum performance.

Again, thank you for choosing an *Esatto* appliance and we look forward to being of service to you.

Kind Regards,
The Residentia Team



CONTENTS

Safety information	2-3
Identifying parts of the fridge	4
Transporting	5
Installation	5
Reversing the door	6-7
Operating instructions	8
Cleaning & Maintenance	8-9
Energy saving tips	10
Disconnection of the appliance	10
Troubleshooting Guide	11
Repairs, Service & Warranty	12
Specifications	13

SAFETY INFORMATION

This manual contains important information on the installation, use and care of your appliance. Please read this manual carefully before use. Follow instructions and keep the manual for future reference.

The appliance is specifically constructed for domestic use and is therefore suitable for the refrigeration and storage of fresh and frozen food and the production of ice-cubes. The appliance has not been designed or manufactured for professional use. Esatto declines all responsibility for damage deriving from improper use of the appliance. The refrigerator has undergone the necessary tests on the tightness of the refrigeration circuit and complies with the safety regulations.



WARNING

The WARNING symbol indicates information that concerns your personal safety



CAUTION

The CAUTION symbol indicates information on avoiding damage to the appliance



R600a WARNING LABEL

R600a Refrigerant Warning



- This appliance contains a small quantity of flammable, non-synthetic R600a refrigerant.
- Ensure that the tubing of the refrigerant circuit is not damaged during transportation and installation.
- Ensure careful installing, handling and disposing to avoid safety hazards. If accidental damage occurs, keep the appliance away from open fires or devices that produce sparks, unplug the appliance and call an authorised service agent. Thoroughly ventilate the room in which the appliance is situated for several minutes.
- Leaking refrigerant may cause eye injuries or could ignite.
- Hydrocarbon refrigerants have excellent refrigerant properties, minimal global warming potential and no ozone depletion potential.
- Hydrocarbon refrigerants cannot be 'retrofitted' to an appliance that has not been designed and approved to use that type of refrigerant.
- The room for installing the appliance must be at least 1m³ per 8g of refrigerant. The amount of refrigerant in the appliance can be found on the rating plate attached to the appliance.

SAFETY INFORMATION

Safety Precautions

- The refrigerator is designed to operate on a single phase power supply within a voltage range of 220-240V/50Hz.
- Do not allow any sharp objects to come in contact with the refrigerant system to avoid damage to the refrigerant circuit.
- This product is for indoor use only.
- Do not place electrical items or cooking equipment nearby. Keep away from substances which could cause ignition and ensure good ventilation is always available.
- Do not use electrical appliances inside the food storage compartments of the appliance unless they are the type recommended by the manufacturer.
- Do not place objects on top of the appliance which are magnetic, heavy or filled with water.
- If the supply cord is damaged, it must be replaced by authorised service personnel, service agent or similarly qualified persons in order to avoid a hazard.
- Do not store flammable, explosive, volatile and highly corrosive materials in the refrigerator. Containers with flammable gases or liquids can leak at low temperature. There is a risk of explosion or fire.
- Do not splash water on the appliance. It may cause malfunction or electric shock.
- Do not place or operate any electrical appliance in the refrigerator.
- Always switch off and unplug the appliance before cleaning.
- This appliance is not intended for use by persons (including children) with reduced physical, sensory or mental capabilities, or lack of experience and knowledge, unless they have been given supervision or instruction concerning use of the appliance by a person responsible for their safety.

Safety of children



WARNING

- Young children should be supervised to ensure that they do not play with the appliance.
- Packing (e.g. plastic wraps, polystyrene etc.) can be dangerous for children. There is a risk of suffocation. Keep packaging materials away from children.

Information on disposal

Most of the packing material used is recyclable. Please separate the plastic and cardboard and dispose through your local recycling depot or place in appropriate recycling collection bins.

If disposing of this appliance, please contact your local authority for safe disposal. Incorrect disposal may cause injury to the user or flammable gases may cause environmental damage. Remove the doors, cut off the main cable, break or remove spring or bolt catches to prevent children from getting trapped or harming themselves.

IDENTIFYING PARTS OF THE FRIDGE

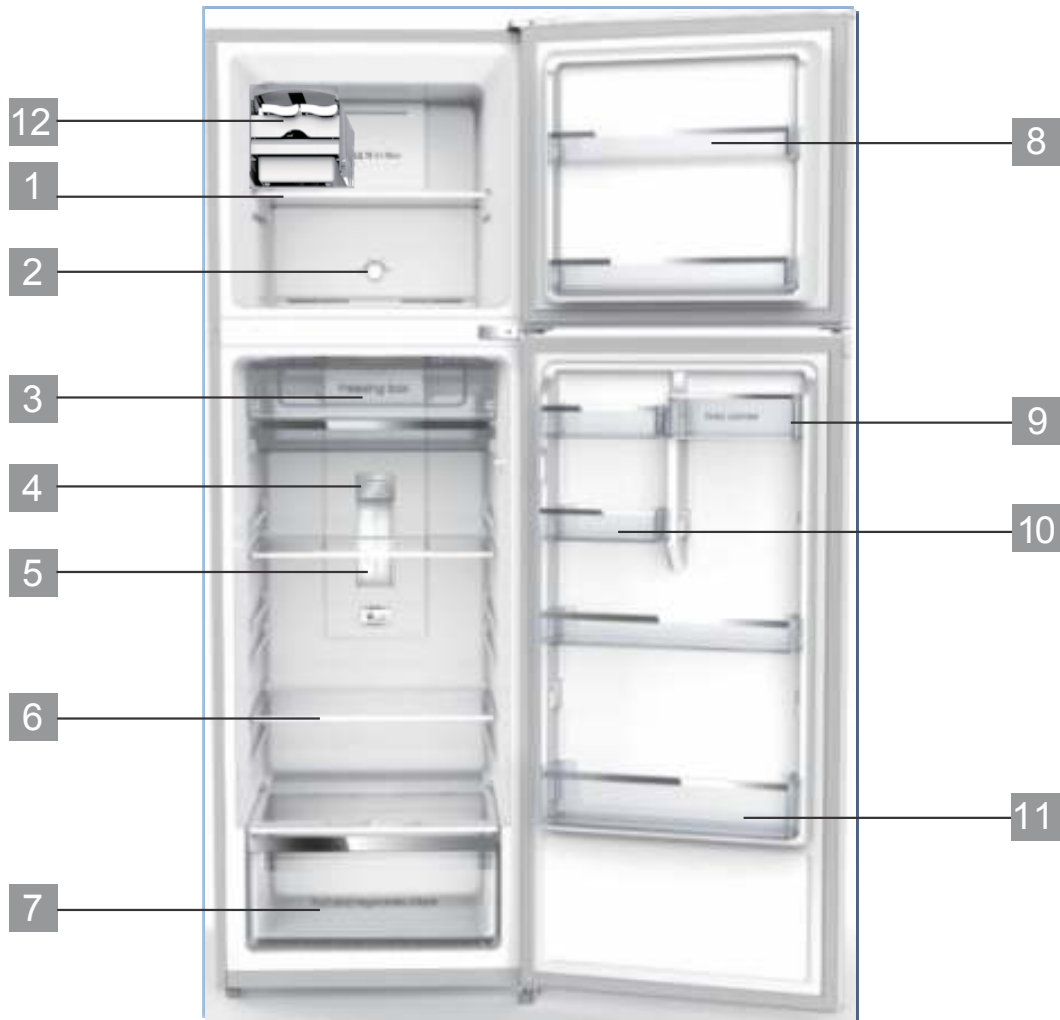

NOTE: Photo for reference only. The interior of different model may vary slightly.

- 1 Freezer glass shelf
- 2 Knob of freezing ventilation door
- 3 Deli compartment
- 4 Refrigerator temperature control panel
- 5 Refrigerator LED light
- 6 Refrigerator glass shelf
- 7 Fruit & vegetable drawer
- 8 Freezer door bin
- 9 Refrigerator sealed door bin
- 10 Refrigerator small bottle bin
- 11 Refrigerator large bottle bin with egg bracket
- 12 Removable twist ice maker

TRANSPORTING

Keep the refrigerator upright and avoid squeezing or vibration during transport. Avoid a slanting angle over 45 degrees during handling. Avoid the door or top cap from being under excessive stress when moving, otherwise it may become deformed.



Do not connect your refrigerator to the power supply immediately after it is placed vertically. You should keep it standing for at least 3 hours before connection to let it settle.

INSTALLATION

Remove all packaging material and adhesive tape before using your new refrigerator. This includes the foam base and all adhesive tape holding the refrigerator accessories inside and outside.

Clean both the inside and outside of the refrigerator with a soft cloth and lukewarm soapy water.

Positioning your refrigerator

Place your refrigerator in a well ventilated area away from a heat source and direct sunlight. Do not install the refrigerator in a damp or wet location as this may cause damage to the insulation and result in leakage. Condensation may also build up on the outer cabinet causing rust.

Use the front two adjustable feet to level the refrigerator. Rotate the feet in a clockwise direction to raise the refrigerator and anti-clockwise to lower. Ensure the refrigerator slightly tilts backwards so that the drawers and doors self-close to provide a consistent closed seal.

Allow for adequate ventilation around your refrigerator

There should be a clearance of at least 300mm from the top of your refrigerator, and 50mm from either the sides of the refrigerator (or) the back of the unit. If the refrigerator is to sit flush with the cabinetry, then a 50mm clearance must be available to allow the doors to open freely and enable the removal of bins and shelves.

The minimum clearance recommended at each side is 5mm, if this is the case the doors must sit proud of the cabinetry by 50mm (not flush). A 5mm side clearance will require 50mm of airspace at the back of the unit to allow for adequate ventilation.

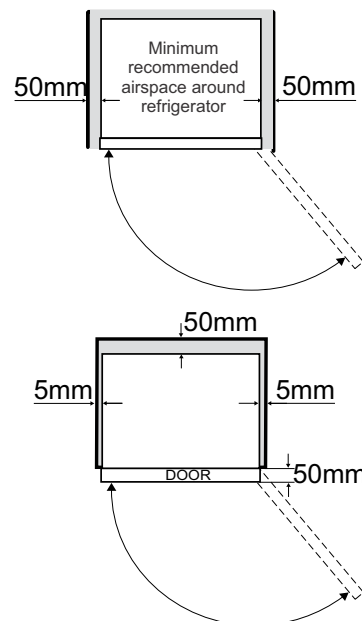

REVERSING THE DOOR



Please ensure the refrigerator is unplugged from the main power source and any items are removed from inside the refrigerator and door bins before reversing the door.

Follow below steps to reverse the door from the supplied position.

1. Remove the top right hinge cover.

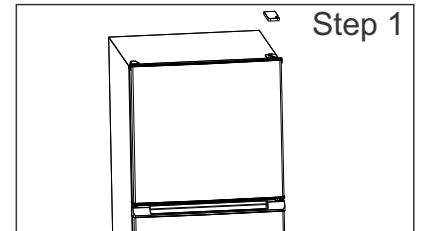

2. Remove the top hinge with screw driver.

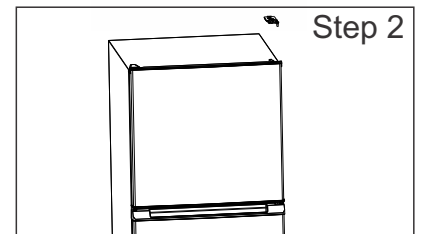

3. Remove the F-door.

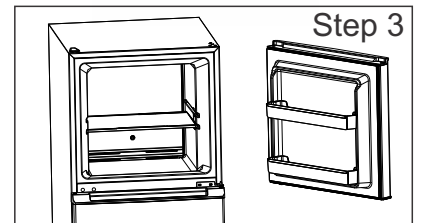

4. Remove the middle hinge with screw driver.

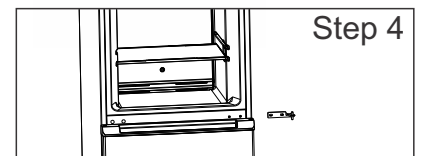

5. Remove the R-door.

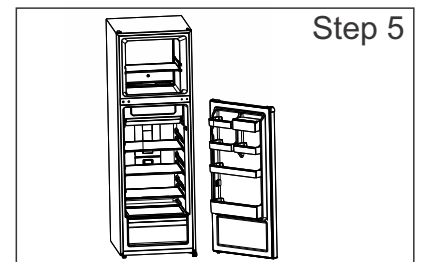

6. Remove the lower hinge with screw driver.

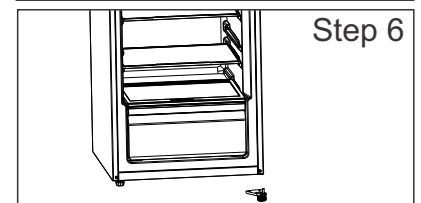

7. Remove the hinge shaft cover, middle beam hole cover, and the adjustable feet.

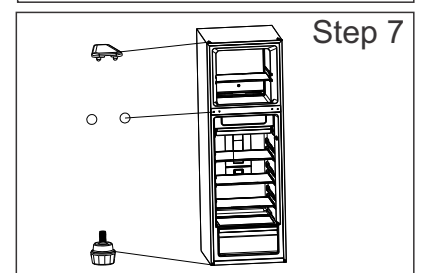

REVERSING THE DOOR

8. Install the adjustable feet to the right side in front of the refrigerator, mount the lower hinge subassembly to the left side in front of the refrigerator.

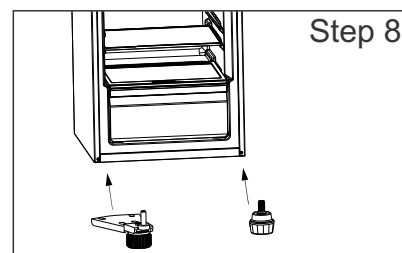

9. Remove the hinge bushing and door stop of the R-door and F-door with screw driver, and install them to the other side of the doors.

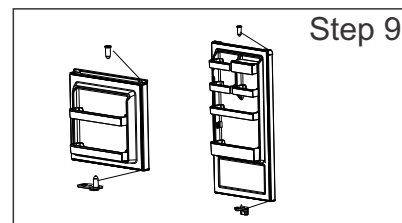

10. Install the R-door onto the lower hinge.

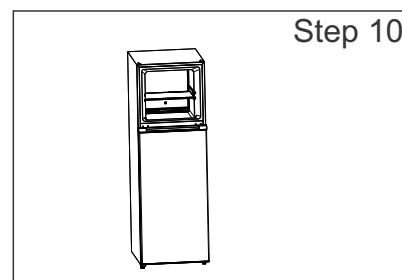

11. Use a screw driver to mount the middle hinge to the left side of the middle beam in front of the refrigerator.

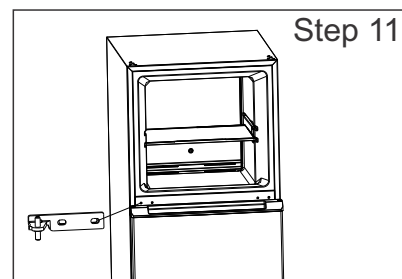

12. Install the F-door onto the middle hinge.

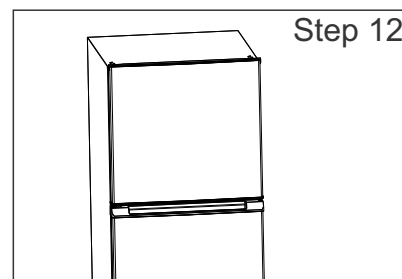

13. Use a screw driver to mount the top hinge to the left side of the top of the refrigerator.

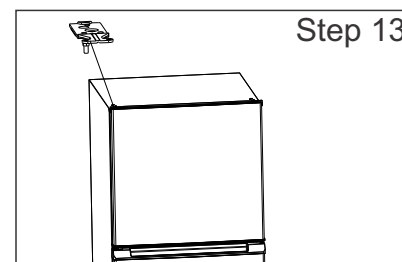

14. Mount the top left hinge cover to the top hinge, mount the hinge shaft cover to the top right of the refrigerator, mount the middle beam hole cover to the right side hole of the middle beam.

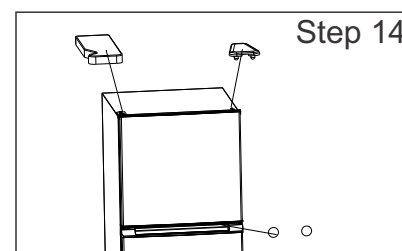

OPERATING INSTRUCTIONS

Controlling the temperature

Refrigerator temperature:

Press SET key to select temperature from level 1 to level 5 (coldest). The refrigerator will run under the setting temperature after 15 seconds automatically.

When the refrigerator is powered on, all temperature level LED will light on for 3 seconds, and then the current setting temperature level displays.

NOTE: Where there is no failure, the LED light displays current setting temperature level. On the occurrence of a failure, the corresponding LED light will give a combined display of failure code (see failure code section below).

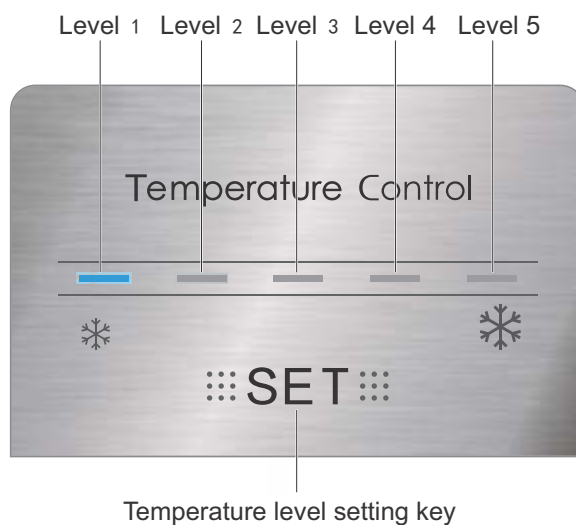

Freezer temperature:

The temperature of the freezer can be controlled manually by adjusting the knob of freezing ventilation door (page 4 item 3). Turn to Normal position for normal use or turn the knob clockwise for colder temperature.

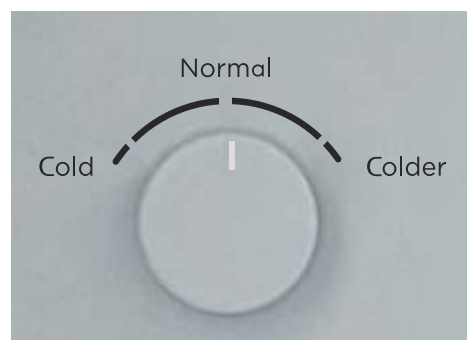

Failure code

The following table is a list of the fault indicators and corresponding alarms.

Status of corresponding indicators /Temperature control LED	Failure
	Refrigerator compartment temperature sensor failure
	Freezer compartment temperature sensor failure
	Ambient temperature sensor failure

CLEANING & MAINTENANCE

Cleaning the appliance



Before cleaning: Turn appliance off at the power point, then remove the power cord from the outlet. This will make sure there is no chance of electric shock.

Interior

Clean the refrigerator interior regularly. Turn power off. Wipe the interior with a soft cloth and lukewarm soapy water. Wipe away any food spills thoroughly. Dry all surfaces and removable parts. Avoid getting water on the refrigerator controls. If you have taken out any removable parts, replace them and switch on the power before re-stocking the refrigerator.

Exterior

Clean the refrigerator with only lukewarm soapy water and a soft cloth. Rinse with clean water and then wipe the surface with a soft clean cloth to remove any soap residue.

Door seals

Take care to keep door seals clean. Sticky food and drink can cause seals to stick to the cabinet and tear when you open the door. Wash seal with a mild detergent and warm water. Rinse thoroughly and dry.



Never use hot water, solvents, commercial kitchen cleaners, aerosol cleaners, metal polishers, caustic or abrasive cleaners or scourers to clean the appliance as they will damage it. Many commercially available cleaning products and detergents contain solvents that will damage your refrigerator. When cleaning, using only a soft cloth and lukewarm soapy water.

Replacing the Interior light

The refrigerator light can only be replaced by an authorised service agent. If the light stops working, please contact Esatto Service (refer to page 12).

Please check the points below after maintenance:

- (1) Is there any damage to the power lead?
- (2) Can the power plug be inserted into the power socket correctly?
- (3) Is the power plug and/or lead heating up?

ENERGY SAVING TIPS

1. Reduce opening the door frequently. This will increase the appliance efficiency and reduce power consumption.
2. To maintain good air circulation within the refrigerator cabinet, keep the shelves, fruit and vegetable drawer in the original positions as supplied.
3. There should always be some space between food items for proper air circulation.
4. Hot food should be cooled down before placing into the appliance, otherwise the interior temperature and power consumption will increase.

DISCONNECTION OF THE APPLIANCE



If unplugging the appliance from the power outlet, please leave at least 5 minutes before re-connection.

1. Power failure

During a power failure, do not put additional food in the appliance and reduce opening the door.

If power failure is anticipated beforehand, place several ice cubes into a container and place in the top of the refrigerator.

2. Power failure during vacation

Before departure of a short vacation, remove any items that could spoil if a power failure occurs, and ensure the doors are closed firmly.

If going on a long vacation, remove all items, clean and wipe dry the internal of the appliance, disconnect the power and leave the doors open.

3. Storage of appliance

If the refrigerator needs to be switched off for a long period of time (storage), remove all items, unplug the appliance from the power outlet, clean and wipe dry the interior. The door should be wedged open slightly for air circulation in order to prevent unpleasant odours.

TROUBLESHOOTING GUIDE

If you think something may be wrong with your refrigerator, you can carry out some easy checks before calling for service. You may locate the problem and spare yourself from inconvenience, saving time and money.

SYMPTOM	SUGGESTION
Refrigerator is not operating	<ul style="list-style-type: none">• Check that the power cord is plugged into the power outlet properly and that the outlet is switched “ON”.• Try running another appliance from the power outlet. If no power is coming from the outlet you may have blown a fuse or tripped a circuit of your household power supply.• Try adjusting the temperature control to a slightly “colder” position.
Unusual noise	<ul style="list-style-type: none">• The flow of refrigerant through the pipeline coil could cause gurgling, similar to water boiling. This is the normal function of the appliance.• It is quite normal for noise to seem louder just after the refrigerator starts operating.• Other strange sounds may mean that you need to check and take action. For example, noises may mean that:<ul style="list-style-type: none">- The cabinet is not level.- The floor is uneven or weak.- Bottles are badly placed and rattling.- There are vibrations from an object on top of or behind or beside the refrigerator.- The back of the refrigerator cabinet is touching the wall.
Compressor seems to run more than expected	<ul style="list-style-type: none">• Are doors kept open too long or too often?• Are controls set too cold?• Have large amounts of warm food just recently been stored?• If the day is hot or the room is very warm, the refrigerator will need to run more than normal.• The refrigerator will run more than normal just after you install it or when it has been turned off for a long time.
Temperature in the refrigerator is too warm	<ul style="list-style-type: none">• Check that the appliance has enough clearance at the sides, back and top. Refer to installation instruction on page 5.• Refer to “Controlling the temperature” on page 8.• You may have kept the door open too long or too frequently.• Food containers or packaging may be holding a door open.
Food is frozen inside the refrigerator compartment	<ul style="list-style-type: none">• Check if the food is placed near the air outlet.
The door will not close	<ul style="list-style-type: none">• Check whether the front of the refrigerator is tilted back slightly to allow the doors to self close.• Check whether something is holding the door open.

The following cases are not malfunctions:

Moisture may form as condensation on the outside of the appliance during humid conditions. To remove excess moisture, wipe clean.

It is normal that the sides of the appliance and the turnover beam will get warm as a result of the refrigeration system operation.

REPAIRS, SERVICE & WARRANTY

It is hazardous for anyone installing, removing, altering, repairing servicing, testing or certifying the gas system of a gas device (i.e. charging, discharging or breaking into the refrigeration system that uses hydrocarbon refrigerants). Only an Authorised Service Person can carry out servicing or repairs to this appliance.

If service is required

If you have a problem which persists after you have made the checks listed in the Troubleshooting Guide, please contact:

Customer Care on 1300 11 4357

Please refer to the enclosed warranty card or visit www.residentiagroup.com.au for warranty information. Ensure you have the appliance model number and proof of purchase handy before calling Residentia Customer Care to enquire about a warranty claim.

Complete and retain the following information for your records:

Model No.	
Serial No.	
Date of purchase	
Retailer	

Please retain proof of purchase for warranty claims.

SPECIFICATIONS

Model		ETM207X ETM207W	ETM239X ETM239W	ETM268X ETM268W
Climate Class		T	T	T
Classification of Protection Against Electric Shock		I	I	I
Rated Total Gross Volume	Refrigerator	140L	172L	201L
	Freezer	67L	67L	67L
Voltage		220-240V / 50Hz	220-240V / 50Hz	220-240V / 50Hz
Refrigerant type		R600a	R600a	R600a
Ambient Operating temperature		43°C	43°C	43°C
Dimensions	Height	1372mm	1522mm	1657mm
	Width	545mm	545mm	545mm
	Depth	623mm	623mm	623mm
IP rating		IPX0	IPX0	IPX0
Net Weight		47.5kg	51kg	55kg

NOTE:

Product specifications are subject to change without prior notice.

This product is subject to continuous improvement, which may not be completely consistent with the manual, however the functions and operating methods will not change.

Warranty

WARRANTY TERMS AND CONDITIONS REFRIGERATION APPLIANCES

→ This document sets out the terms and conditions of the product warranties for Residentia Group Appliances. It is an important document. Please keep it with your proof of purchase documents in a safe place for future reference should you require service for your Appliance.

1. In this warranty
 - (a) 'acceptable quality' as referred to in clause 10 of this warranty has the same meaning referred to in the ACL;
 - (b) 'ACL' means Trade Practices Amendment (Australian Consumer Law) Act (No.2) 2010;
 - (c) 'Appliance' means any Residentia Group product purchased by you accompanied by this document;
 - (d) 'ASR' means Residentia Group authorised service representative;
 - (e) 'Residentia Group' means Residentia Group Pty Ltd of 20 Yaltara Avenue, Bundoora Victoria 3083, ACN 600 546 656 in respect of Appliances purchased in Australia;
 - (f) 'major failure' as referred to in clause 10 of this warranty has the same meaning referred to in the ACL and includes a situation when an Appliance cannot be repaired or it is uneconomic for Residentia Group, at its discretion, to repair an Appliance during the Warranty Period;
 - (g) 'Warranty Period' means:
 - (i) where the Appliance is used for personal, domestic or household use (i.e. normal single family use) as set out in the instruction manual, the Appliance is warranted against manufacturing defects in Australia for 12 months following the date of original purchase of the Appliance;
 - (h) 'you' means the purchaser of the Appliance not having purchased the Appliance for re-sale, and 'your' has a corresponding meaning.
2. This warranty only applies to Appliances purchased and used in Australia and is in addition to (and does not exclude, restrict, or modify in any way) any non-excludable statutory warranties in Australia.
3. During the Warranty Period Residentia Group or its ASR will, at no extra charge if your Appliance is readily accessible for service, without special equipment and subject to these terms and conditions, repair or replace any parts which it considers to be defective. Residentia Group or its ASR may use remanufactured parts to repair your Appliance. You agree that any replaced Appliances or parts become the property of Residentia Group. This warranty does not apply to light globes, batteries, filters or similar perishable parts.
4. Parts and Appliances not supplied by Residentia Group are not covered by this warranty.
5. You will bear the cost of transportation, travel and delivery of the Appliance to and from Residentia Group or its ASR. If you reside outside of the service area, you will bear the cost of:
 - (a) travel of an authorised representative;
 - (b) transportation and delivery of the Appliance to and from Residentia Group or its ASR, in all instances, unless the Appliance is transported by Residentia Group or its ASR, the Appliance is transported at the owner's cost and risk while in transit to and from Residentia Group or its ASR.
6. Proof of purchase is required before you can make a claim under this warranty.

Warranty continued

7. You may not make a claim under this warranty unless the defect claimed is due to faulty or defective parts or workmanship. Residentia Group is not liable in the following situations (which are not exhaustive):
- (a) the Appliance is damaged by:
 - (i) accident
 - (ii) misuse or abuse, including failure to properly maintain or service
 - (iii) normal wear and tear
 - (iv) power surges, electrical storm damage or incorrect power supply
 - (v) incomplete or improper installation
 - (vi) incorrect, improper or inappropriate operation
 - (vii) insect or vermin infestation
 - (viii) failure to comply with any additional instructions supplied with the Appliance;
 - (b) the Appliance is modified without authority from Residentia Group in writing;
 - (c) the Appliance's serial number or warranty seal has been removed or defaced;
 - (d) the Appliance was serviced or repaired by anyone other than Residentia Group, an authorised repairer or ASR.
8. This warranty, the contract to which it relates and the relationship between you and Residentia Group are governed by the law applicable where the Appliance was purchased.
9. To the extent permitted by law, Residentia Group excludes all warranties and liabilities (other than as contained in this document) including liability for any loss or damage whether direct or indirect arising from your purchase, use or non use of the Appliance.
10. For Appliances and services provided by Residentia Group in Australia, the Appliances come with a guarantee by Residentia Group that cannot be excluded under the Australian Consumer Law. You are entitled to a replacement or refund for a major failure and for compensation for any other reasonably foreseeable loss or damage. You are also entitled to have the Appliance repaired or replaced if the Appliance fails to be of acceptable quality and the failure does not amount to a major failure. The benefits to you given by this warranty are in addition to your other rights and remedies under a law in relation to the Appliances or services to which the warranty relates.
11. At all times during the Warranty Period, Residentia Group shall, at its discretion, determine whether repair, replacement or refund will apply if an Appliance has a valid warranty claim applicable to it.
12. To enquire about claiming under this warranty, please follow these steps:
- (a) carefully check the operating instructions, user manual and the terms of this warranty;
 - (b) have the model and serial number of the Appliance available;
 - (c) have the proof of purchase (e.g. an invoice) available;
 - (d) telephone the numbers shown below.
13. You accept that if you make a warranty claim, Residentia Group and its ASR may exchange information in relation to you to enable Residentia Group to meet its obligations under this warranty.

IMPORTANT Before calling for service, please ensure that the steps in point 12 have been followed.

Service: Please call 1300 11 HELP (4357)

Spare Parts: Please call 1300 11 SPARE (7727)

This page is intentionally left blank.

This page is intentionally left blank.

Model Code/s:

ETM207X
ETM207W
ETM239X
ETM239W
ETM268X
ETM268W

Residentia



E2447